



CATÁ 20 LOGO 23

Todo lo que necesitas en un solo lugar
Más de 15 años acompañando a nuestros clientes

ACCESORIOS DE BRONCE ROSCADO

- 1000/01 Rosca con tuerca 1/2 bronce
- 1000/02 Rosca con tuerca 3/4 bronce
- 1000/03 Rosca con tuerca 1 bronce
- 1000/04 Rosca con tuerca 1 1/4 bronce
- 1000/05 Rosca con tuerca 1 1/2 bronce
- 1000/06 Rosca con tuerca 2 bronce



- 1000/07 Rosca con tuerca 3/4 x 1/2 bronce
- 1000/08 Rosca con tuerca 1 x 3/4 bronce



- 1000/09 Cupla 1/2 bronce
- 1000/10 Cupla 3/4 bronce
- 1000/11 Cupla 1 bronce
- 1000/12 Cupla 1 1/4 bronce
- 1000/13 Cupla 1 1/2 bronce
- 1000/14 Cupla 2 bronce



- 1000/15 Cupla 1/2 x 3/8 bronce
- 1000/16 Cupla 3/4 x 1/2 bronce
- 1000/17 Cupla 1 x 3/4 bronce
- 1000/18 Cupla 1 x 1/2 bronce
- 1000/19 Cupla 1 1/4 x 1 bronce
- 1000/20 Cupla 1 1/4 x 3/4 bronce
- 1000/21 Cupla 1 1/4 x 1/2 bronce
- 1000/22 Cupla 1 1/2 x 1 1/4 bronce
- 1000/23 Cupla 1 1/2 x 1 bronce
- 1000/24 Cupla 1 1/2 x 3/4 bronce
- 1000/25 Cupla 1 1/2 x 1/2 bronce



- 1000/26 Brida 1/2 bronce
- 1000/27 Brida 3/4 bronce
- 1000/28 Brida 1 bronce
- 1000/29 Brida 1 1/4 bronce
- 1000/30 Brida 1 1/2 bronce
- 1000/31 Brida 2 bronce



1000/32 Tapon macho 1/2 bronce
 1000/33 Tapon macho 3/4 bronce
 1000/34 Tapon macho 1 bronce
 1000/35 Tapon macho 1 1/4 bronce
 1000/36 Tapon macho 1 1/2 bronce
 1000/37 Tapon macho 2 bronce



1000/38 Codo HH 1/2 bronce
 1000/39 Codo HH 3/4 bronce
 1000/40 Codo HH 1 bronce
 1000/41 Codo HH 1 1/4 bronce
 1000/42 Codo HH 1 1/2 bronce
 1000/43 Codo HH 2 bronce



1000/44 Codo 3/4 x 1/2 bronce
 1000/45 Codo 1 x 3/4 bronce
 1000/46 Codo 1 x 1/2 bronce
 1000/47 Codo 1 1/4 x 3/4 bronce



1000/48 Codo MH 1/2 bronce
 1000/49 Codo MH 3/4 bronce
 1000/50 Codo MH 1 bronce
 1000/51 Codo MH 1 1/4 bronce
 1000/52 Codo MH 1 1/2 bronce
 1000/53 Codo MH 2 bronce



1000/54 Buje 3/4 x 1/2 bronce
 1000/55 Buje 1 x 3/4 bronce
 1000/56 Buje 1 x 1/2 bronce
 1000/57 Buje 1 1/4 x 1 bronce
 1000/58 Buje 1 1/4 x 3/4 bronce
 1000/59 Buje 1 1/4 x 1/2 bronce
 1000/60 Buje 1 1/2 x 1 1/4 bronce
 1000/61 Buje 1 1/2 x 1 bronce
 1000/62 Buje 1 1/2 x 3/4 bronce
 1000/63 Buje 1 1/2 x 1/2 bronce
 1000/64 Buje 2 x 1 1/2 bronce
 1000/65 Buje 2 x 1 1/4 bronce
 1000/66 Buje 2 x 1 bronce
 1000/67 Buje 2 x 3/4 bronce



1000/69 Tapa hembra 1/2 bronce
 1000/70 Tapa hembra 3/4 bronce
 1000/71 Tapa hembra 1 bronce
 1000/72 Tapa hembra 1 1/4 bronce
 1000/73 Tapa hembra 1 1/2 bronce
 1000/74 Tapa hembra 2 bronce



1000/75 Tee 1/2 bronce
 1000/76 Tee 3/4 bronce
 1000/77 Tee 1 bronce
 1000/78 Tee 1 1/4 bronce
 1000/79 Tee 1 1/2 bronce
 1000/80 Tee 2 bronce



1000/81 Tee 3/4 x 1/2 bronce
 1000/82 Tee 1 x 3/4 bronce
 1000/83 Tee 1 x 1/2 bronce
 1000/84 Tee 1 1/4 x 1 bronce
 1000/85 Tee 1 1/4 x 3/4 bronce
 1000/86 Tee 1 1/4 x 1/2 bronce
 1000/87 Tee 1 1/2 x 1 1/4 bronce
 1000/88 Tee 1 1/2 x 1 bronce
 1000/89 Tee 1 1/2 x 3/4 bronce
 1000/90 Tee 1 1/2 x 1/2 bronce
 1000/91 Tee 2 x 1 1/2 bronce
 1000/92 Tee 2 x 1 1/4 bronce
 1000/93 Tee 2 x 1 bronce
 1000/94 Tee 2 x 3/4 bronce
 1000/95 Tee 2 x 1/2 bronce



1000/96 Curva MH 45° 1/2 bronce
 1000/97 Curva MH 45° 3/4 bronce
 1000/98 Curva MH 45° 1 bronce



1000/99 Curva HH 45° 1/2 bronce
 1000/100 Curva HH 45° 3/4 bronce
 1000/101 Curva HH 45° 1 bronce



1000/102 Curva HH 90° 1/2 bronce
 1000/103 Curva HH 90° 3/4 bronce
 1000/104 Curva HH 90° 1 bronce



1000/105 Curva MH 90° 1/2 bronce
 1000/106 Curva MH 90° 3/4 bronce
 1000/107 Curva MH 90° 1 bronce



1000/108 Union doble 1/2 bronce
 1000/109 Union doble 3/4 bronce
 1000/110 Union doble 1 bronce
 1000/111 Union doble 1 1/4 bronce
 1000/112 Union doble 1 1/2 bronce
 1000/113 Union doble 2 bronce



ACCESORIOS PARA GAS BRONCE TRAFILADO

1010/01 Reduccion MH 1/2 x 1/8
 1010/02 Reduccion MH 1/2 x 1/4
 1010/03 Reduccion MH 1/2 x 3/8
 1010/04 Reduccion MH 3/8 x 1/8
 1010/05 Reduccion MH 3/8 x 1/4
 1010/06 Reduccion MH 1/4 x 1/8



1010/07 Reduccion MM 1/2 x 1/8
 1010/08 Reduccion MM 1/2 x 1/4
 1010/09 Reduccion MM 1/2 x 3/8
 1010/10 Reduccion MM 3/8 x 1/8
 1010/11 Reduccion MM 3/8 x 1/4
 1010/12 Reduccion MM 1/4 x 1/8



1010/13 Codo MH 1/2 x 1/8
 1010/14 Codo MH 1/2 x 1/4
 1010/15 Codo MH 1/2 x 3/8
 1010/16 Codo MH 3/8 x 1/8
 1010/17 Codo MH 3/8 x 1/4
 1010/18 Codo MH 1/4 x 1/8



1010/19 Codo MM 1/2 x 1/8
 1010/20 Codo MM 1/2 x 1/4
 1010/21 Codo MM 1/2 x 3/8
 1010/22 Codo MM 3/8 x 1/8
 1010/23 Codo MM 3/8 x 1/4
 1010/24 Codo MM 1/4 x 1/8



1010/25 Cupla 1/2 x 1/8
 1010/26 Cupla 1/2 x 1/4
 1010/27 Cupla 1/2 x 3/8
 1010/28 Cupla 3/8 x 1/8
 1010/29 Cupla 3/8 x 1/4
 1010/30 Cupla 1/4 x 1/8



1010/31 Buje 1/2 x 1/8
 1010/32 Buje 1/2 x 1/4
 1010/33 Buje 1/2 x 3/8
 1010/34 Buje 3/8 x 1/8
 1010/35 Buje 3/8 x 1/4
 1010/36 Buje 1/4 x 1/8



1010/37 Codo HH 3/8
 1010/38 Codo HH 1/4
 1010/39 Codo HH 1/8



1010/40 Codo MH 3/8
 1010/41 Codo MH 1/4
 1010/42 Codo MH 1/8



1010/43 Codo MM 3/8
 1010/44 Codo MM 1/4
 1010/45 Codo MM 1/8



1010/46 Cupla 3/8
 1010/47 Cupla 1/4
 1010/48 Cupla 1/8



1010/49 Rosca con tuerca 3/8
1010/50 Rosca con tuerca 1/4
1010/51 Rosca con tuerca 1/8



1010/52 Tee H 3/8
1010/53 Tee H 1/4
1010/54 Tee H 1/8



1010/55 Tee M 3/8
1010/56 Tee M 1/4
1010/57 Tee M 1/8



1010/58 Teton H 1/2
1010/59 Teton H 3/8
1010/60 Teton H 1/4
1010/61 Teton H 1/8



1010/62 Teton M 1/2
1010/63 Teton M 3/8
1010/64 Teton M 1/4
1010/65 Teton M 1/8



1010/66 Teton curvo H 1/2
1010/67 Teton curvo M 1/2



1010/68 Tuerca de ajuste 1/2
1010/69 Tuerca de ajuste 3/8
1010/70 Tuerca de ajuste 1/4
1010/71 Tuerca de ajuste 1/8



1010/72 Tapa 3/8
1010/73 Tapa 1/4
1010/74 Tapa 1/8



1010/75 Tapon 3/8
1010/76 Tapon 1/4
1010/77 Tapon 1/8



1010/78 Tee toma goma 3/8



1010/79 Union manguera gas 3/8



1010/80 Virola 1/2
1010/81 Virola 3/8
1010/82 Virola 1/4
1010/83 Virola 1/8



1010/84 Perno y mariposa garrafa de 3 KG
1010/85 Perno y mariposa garrafa de 10 KG



1010/86 Adaptador para garrafa de 3 a 10 KG



1010/87 Caja calizuales 7 medidas



ACCESORIOS EPOXI

1020/01 Curva MH 90° 1/2 Epoxi
1020/02 Curva MH 90° 3/4 Epoxi
1020/03 Curva MH 90° 1 Epoxi



1020/04 Curva HH 90° 1/2 Epoxi
1020/05 Curva HH 90° 3/4 Epoxi
1020/06 Curva HH 90° 1 Epoxi



1020/07 Curva MH 45° 1/2 Epoxi
1020/08 Curva MH 45° 3/4 Epoxi
1020/09 Curva MH 45° 1 Epoxi



1020/10 Curva HH 45° 1/2 Epoxi
1020/11 Curva HH 45° 3/4 Epoxi
1020/12 Curva HH 45° 1 Epoxi



1020/13 Codo HH 1/2 Epoxi
1020/14 Codo HH 3/4 Epoxi
1020/15 Codo HH 1 Epoxi
1020/60 Codo HH 1 1/4 Epoxi



1020/16 Codo MH 1/2 Epoxi
1020/17 Codo MH 3/4 Epoxi
1020/18 Codo MH 1 Epoxi
1020/63 Codo MH 1 1/4 Epoxi



1020/19 Codo reduccion 3/4 x 1/2 Epoxi
1020/20 Codo reduccion 1 x 3/4 Epoxi



1020/21 Cuplas 1/2 Epoxi
1020/22 Cuplas 3/4 Epoxi
1020/23 Cuplas 1 Epoxi
1020/61 Cuplas 1 1/4 Epoxi



1020/24 Tapon macho 1/2 Epoxi
1020/25 Tapon macho 3/4 Epoxi
1020/26 Tapon macho 1 Epoxi
1020/65 Tapon macho 1 1/4 Epoxi



1020/27 Tapa hembra 1/2 Epoxi
1020/28 Tapa hembra 3/4 Epoxi
1020/29 Tapa hembra 1 Epoxi
1020/66 Tapa hembra 1 1/4 Epoxi



1020/30 Tuercas planas 1/2 Epoxi
1020/31 Tuercas planas 3/4 Epoxi
1020/32 Tuercas planas 1 Epoxi



1020/33 Brida 1/2 Epoxi
1020/34 Brida 3/4 Epoxi
1020/35 Brida 1 Epoxi



1020/36 Union doble conica 1/2 Epoxi
1020/37 Union doble conica 3/4 Epoxi
1020/38 Union doble conica 1 Epoxi
1020/64 Union doble conica 1 1/4 Epoxi



1020/39 Tee 1/2 Epoxi
1020/40 Tee 3/4 Epoxi
1020/41 Tee 1 Epoxi
1020/62 Tee 1 1/4 Epoxi



1020/42 Tee reduccion 3/4 x 1/2 Epoxi
1020/43 Tee reduccion 1 x 3/4 Epoxi
1020/44 Tee reduccion 1 x 1/2 Epoxi



1020/45 Buje 3/4 x 1/2 Epoxi
1020/46 Buje 1 x 3/4 Epoxi
1020/47 Buje 1 x 1/2 Epoxi
1020/57 Buje 1 1/4 x 1 Epoxi
1020/58 Buje 1 1/4 x 3/4 Epoxi
1020/59 Buje 1 1/2 x 1 1/4 Epoxi



1020/48	Cruz 1/2 Epoxi
1020/49	Cruz 3/4 Epoxi
1020/50	Cruz 1 Epoxi
1020/51	Cupla reduccion 3/4 x 1/2 Epoxi
1020/52	Cupla reduccion 1 x 3/4 Epoxi
1020/53	Cupla reduccion 1 x 1/2 Epoxi
1020/54	Rosca con tuerca 1/2 Epoxi
1020/55	Rosca con tuerca 3/4 Epoxi
1020/56	Rosca con tuerca 1 Epoxi



ACCESORIOS GALVANIZADOS

1020/100	Curva MH 90° 1/2 Galvanizado
1020/101	Curva MH 90° 3/4 Galvanizado
1020/102	Curva MH 90° 1 Galvanizado
1020/103	Curva HH 90° 1/2 Galvanizado
1020/104	Curva HH 90° 3/4 Galvanizado
1020/105	Curva HH 90° 1 Galvanizado
1020/106	Curva MH 45° 1/2 Galvanizado
1020/107	Curva MH 45° 3/4 Galvanizado
1020/108	Curva MH 45° 1 Galvanizado
1020/109	Curva HH 45° 1/2 Galvanizado
1020/110	Curva HH 45° 3/4 Galvanizado
1020/111	Curva HH 45° 1 Galvanizado
1020/112	Codo HH 90° 1/2 Galvanizado
1020/113	Codo HH 90° 3/4 Galvanizado
1020/114	Codo HH 90° 1 Galvanizado



1020/115 Codo reduccion 3/4 x 1/2 Galvanizado
 1020/116 Codo reduccion 1 x 3/4 Galvanizado
 1020/117 Codo reduccion 1 x 1/2 Galvanizado



1020/118 Codo MH 90° 1/2 Galvanizado
 1020/119 Codo MH 90° 3/4 Galvanizado
 1020/120 Codo MH 90° 1 Galvanizado



1020/121 Tee 1/2 Galvanizado
 1020/122 Tee 3/4 Galvanizado
 1020/123 Tee 1 Galvanizado



1020/124 Tee reduccion 3/4 x 1/2 Galvanizado
 1020/125 Tee reduccion 1 x 3/4 Galvanizado
 1020/126 Tee reduccion 1 x 1/2 Galvanizado



1020/127 Cruz 1/2 Galvanizado
 1020/128 Cruz 3/4 Galvanizado
 1020/129 Cruz 1 Galvanizado



1020/130 Cupla reduccion 3/4 x 1/2 Galvanizado
 1020/131 Cupla reduccion 1 x 3/4 Galvanizado
 1020/132 Cupla reduccion 1 x 1/2 Galvanizado



1020/133 Buje reduccion 3/4 x 1/2 Galvanizado
 1020/134 Buje reduccion 1 x 3/4 Galvanizado
 1020/135 Buje reduccion 1 x 1/2 Galvanizado
 1020/136 Buje reduccion 1 1/4 x 1 Galvanizado
 1020/137 Buje reduccion 1 1/2 x 1 1/4 Galvanizado



1020/138 Cupla 1/2 Galvanizado
 1020/139 Cupla 3/4 Galvanizado
 1020/140 Cupla 1 Galvanizado



1020/141 Rosca con tuerca 1/2 Galvanizado
 1020/142 Rosca con tuerca 3/4 Galvanizado
 1020/143 Rosca con tuerca 1 Galvanizado



1020/144 Tapon macho 1/2 Galvanizado
 1020/145 Tapon macho 3/4 Galvanizado
 1020/146 Tapon macho 1 Galvanizado



1020/147 Tapa hembra 1/2 Galvanizado
 1020/148 Tapa hembra 3/4 Galvanizado
 1020/149 Tapa hembra 1 Galvanizado



1020/150 Tuerca plana 1/2 Galvanizada
 1020/151 Tuerca plana 3/4 Galvanizada
 1020/152 Tuerca plana 1 Galvanizada



1020/153 Brida 1/2 Galvanizada
 1020/154 Brida 3/4 Galvanizada
 1020/155 Brida 1 Galvanizada



1020/156 Union doble 1/2 Galvanizado
 1020/157 Union doble 3/4 Galvanizado
 1020/158 Union doble 1 Galvanizado



ACCESORIOS DE POLIPROPILENO

1030/01 Rosca con tuerca 1/2 polipropileno
 1030/02 Rosca con tuerca 3/4 polipropileno
 1030/03 Rosca con tuerca 1 polipropileno
 1030/04 Rosca con tuerca 1 1/4 polipropileno
 1030/05 Rosca con tuerca 1 1/2 polipropileno
 1030/06 Rosca con tuerca 2 polipropileno



1030/07 Rosca con tuerca 3/4 x 1/2 polipropileno
 1030/08 Rosca con tuerca 1 x 3/4 polipropileno
 1030/09 Rosca con tuerca 1 x 1/2 polipropileno



1030/10 Cupla 1/2 polipropileno
 1030/11 Cupla 3/4 polipropileno
 1030/12 Cupla 1 polipropileno
 1030/13 Cupla 1 1/4 polipropileno
 1030/14 Cupla 1 1/2 polipropileno
 1030/15 Cupla 2 polipropileno



1030/16 Cupla 1/2 x 3/8 polipropileno
 1030/17 Cupla 3/4 x 1/2 polipropileno
 1030/18 Cupla 1 x 3/4 polipropileno
 1030/19 Cupla 1 x 1/2 polipropileno
 1030/20 Cupla 1 1/4 x 1/2 polipropileno
 1030/20A Cupla 1 1/4 x 3/4 polipropileno
 1030/20B Cupla 1 1/4 x 1 polipropileno
 1030/20C Cupla 1 1/2 x 1 polipropileno



1030/23 Brida 1/2 polipropileno
 1030/24 Brida 3/4 polipropileno
 1030/25 Brida 1 polipropileno
 1030/26 Brida 1 1/4 polipropileno
 1030/27 Brida 1 1/2 polipropileno
 1030/28 Brida 2 polipropileno



1030/38 Tapon macho 1/2 polipropileno
 1030/39 Tapon macho 3/4 polipropileno
 1030/40 Tapon macho 1 polipropileno
 1030/41 Tapon macho 1 1/4 polipropileno
 1030/42 Tapon macho 1 1/2 polipropileno
 1030/43 Tapon macho 2 polipropileno



1030/29 Buje 1/2 x 3/8 polipropileno
 1030/30 Buje 3/4 x 1/2 polipropileno
 1030/31 Buje 1 x 3/4 polipropileno
 1030/32 Buje 1 x 1/2 polipropileno
 1030/33 Buje 1 1/4 x 1 polipropileno
 1030/33A Buje 1 1/4 x 1/2 polipropileno
 1030/33B Buje 1 1/4 x 3/4 polipropileno
 1030/34 Buje 1 1/2 x 1 1/4 polipropileno
 1030/35 Buje 1 1/2 x 1 polipropileno
 1030/35A Buje 1 1/2 x 3/4 polipropileno
 1030/35B Buje 1 1/2 x 1/2 polipropileno
 1030/36 Buje 2 x 1 1/2 polipropileno
 1030/37 Buje 2 x 1 1/4 polipropileno
 1030/37A Buje 2 x 1 polipropileno
 1030/37B Buje 2 x 3/4 polipropileno
 1030/37C Buje 2 x 1/2 polipropileno



1030/44 Codo HH 1/2 polipropileno
 1030/45 Codo HH 3/4 polipropileno
 1030/46 Codo HH 1 polipropileno
 1030/47 Codo HH 1 1/4 polipropileno
 1030/48 Codo HH 1 1/2 polipropileno
 1030/49 Codo HH 2 polipropileno



1030/50 Codo MH 1/2 polipropileno
 1030/51 Codo MH 3/4 polipropileno
 1030/52 Codo MH 1 polipropileno
 1030/53 Codo MH 1 1/4 polipropileno
 1030/54 Codo MH 1 1/2 polipropileno
 1030/55 Codo MH 2 polipropileno



1030/56 Codo 3/4 x 1/2 polipropileno
 1030/57 Codo 1 x 3/4 polipropileno
 1030/58 Codo 1 x 1/2 polipropileno



1030/59 Curva HH 90° 1/2 polipropileno
 1030/60 Curva HH 90° 3/4 polipropileno
 1030/61 Curva HH 90° 1 polipropileno
 1030/62 Curva HH 90° 1 1/4 polipropileno
 1030/63 Curva HH 90° 1 1/2 polipropileno
 1030/64 Curva HH 90° 2 polipropileno



1030/65 Curva HH 45° 1/2 polipropileno
 1030/66 Curva HH 45° 3/4 polipropileno
 1030/67 Curva HH 45° 1 polipropileno



1030/68 Curva MH 90° 1/2 polipropileno
 1030/69 Curva MH 90° 3/4 polipropileno
 1030/70 Curva MH 90° 1 polipropileno
 1030/71 Curva MH 90° 1 1/4 polipropileno
 1030/72 Curva MH 90° 1 1/2 polipropileno
 1030/73 Curva MH 90° 2 polipropileno



1030/74 Curva MH 45° 1/2 polipropileno
 1030/75 Curva MH 45° 3/4 polipropileno
 1030/76 Curva MH 45° 1 polipropileno



1030/77 Tee 1/2 polipropileno
 1030/78 Tee 3/4 polipropileno
 1030/79 Tee 1 polipropileno
 1030/80 Tee 1 1/4 polipropileno
 1030/81 Tee 1 1/2 polipropileno
 1030/82 Tee 2 polipropileno



1030/83 Tee 3/4 x 1/2 polipropileno
 1030/84 Tee 1 x 3/4 polipropileno
 1030/85 Tee 1 x 1/2 polipropileno
 1030/86 Tee 1 1/4 x 1 polipropileno
 1030/87 Tee 1 1/2 x 1 1/4 polipropileno
 1030/88 Tee 2 x 1 1/2 polipropileno



1030/89 Union doble 1/2 polipropileno
 1030/90 Union doble 3/4 polipropileno
 1030/91 Union doble 1 polipropileno
 1030/92 Union doble 1 1/4 polipropileno
 1030/93 Union doble 1 1/2 polipropileno
 1030/94 Union doble 2 polipropileno



1030/95 Tapa hembra 1/2 polipropileno
 1030/96 Tapa hembra 3/4 polipropileno
 1030/97 Tapa hembra 1 polipropileno
 1030/98 Tapa hembra 1 1/4 polipropileno
 1030/99 Tapa hembra 1 1/2 polipropileno
 1030/100 Tapa hembra 2 polipropileno



1030/101 Conexión tanque completa 1/2
 1030/102 Conexión tanque completa 3/4
 1030/103 Conexión tanque completa 1
 1030/104 Conexión tanque completa 1 1/4
 1030/105 Conexión tanque completa 1 1/2
 1030/106 Conexión tanque completa 2



1030/107 Cruz 1/2 polipropileno
 1030/108 Cruz 3/4 polipropileno
 1030/108B Cruz 1 polipropileno



1030/109 Cupla MH 1/2 polipropileno
 1030/110 Cupla MH 3/4 polipropileno
 1030/111 Cupla MH 1 polipropileno



1030/112 Codo HH 1/2 45 polipropileno
 1030/113 Codo HH 3/4 45 polipropileno



ACCESORIOS DE POLIPOPILENO IPS

5000/301 IPS Codo HH 1/2
 5000/302 IPS Codo HH 3/4
 5000/303 IPS Codo HH 1
 5000/304 IPS Codo HH 1 1/4
 5000/305 IPS Codo HH 1 1/2
 5000/306 IPS Codo HH 2



5000/321 IPS Codo MH 1/2
 5000/322 IPS Codo MH 3/4
 5000/323 IPS Codo MH 1
 5000/324 IPS Codo MH 1 1/4
 5000/325 IPS Codo MH 1 1/2
 5000/326 IPS Codo MH 2



5000/331 IPS Codo HH 1/2 45
 5000/332 IPS Codo HH 3/4 45
 5000/333 IPS Codo HH 1 45



5000/351 IPS Cruz 1/2
 5000/352 IPS Cruz 3/4
 5000/353 IPS Cruz 1



5000/361 IPS Tee 1/2
 5000/362 IPS Tee 3/4
 5000/363 IPS Tee 1
 5000/364 IPS Tee 1 1/4
 5000/365 IPS Tee 1 1/2
 5000/366 IPS Tee 2



5000/391 IPS Cupla 1/2
 5000/392 IPS Cupla 3/4
 5000/393 IPS Cupla 1
 5000/394 IPS Cupla 1 1/4
 5000/395 IPS Cupla 1 1/2
 5000/396 IPS Cupla 2



5000/411 IPS Rosca con tuerca 1/2
 5000/412 IPS Rosca con tuerca 3/4
 5000/413 IPS Rosca con tuerca 1
 5000/414 IPS Rosca con tuerca 1 1/4
 5000/415 IPS Rosca con tuerca 1 1/2
 5000/416 IPS Rosca con tuerca 2



5000/501 IPS Tapon macho 1/2
 5000/502 IPS Tapon macho 3/4
 5000/503 IPS Tapon macho 1
 5000/504 IPS Tapon macho 1 1/4
 5000/505 IPS Tapon macho 1 1/2
 5000/506 IPS Tapon macho 2



5000/511 IPS Tapa hembra 1/2
 5000/512 IPS Tapa hembra 3/4
 5000/513 IPS Tapa hembra 1
 5000/514 IPS Tapa hembra 1 1/4
 5000/515 IPS Tapa hembra 1 1/2
 5000/516 IPS Tapa hembra 2



5000/571 IPS Curva MH 90 1/2
 5000/572 IPS Curva MH 90 3/4
 5000/573 IPS Curva MH 90 1



5000/581 IPS Curva HH 90 1/2
 5000/582 IPS Curva HH 90 3/4
 5000/583 IPS Curva HH 90 1
 5000/584 IPS Curva HH 90 1 1/4
 5000/585 IPS Curva HH 90 1 1/2
 5000/586 IPS Curva HH 90 2



5000/591 IPS Cupla MH 1/2
 5000/592 IPS Cupla MH 3/4



5000/811 IPS Sobrepasso MM 1/2
 5000/812 IPS Sobrepasso MM 3/4
 5000/813 IPS Sobrepasso MM 1



5000/311 IPS Codo reduccion 90 HH 1/2X 3/8
 5000/308 IPS Codo reduccion 90 HH 3/4X 1/2
 5000/310 IPS Codo reduccion 90 HH 1X 1/2
 5000/309 IPS Codo reduccion 90 HH 1X 3/4



5000/372 IPS TE reduccion 90 HHH 1/2X 3/4X 1/2
 5000/371 IPS TE reduccion 90 HHH 1/2X 3/8X 1/2
 5000/368 IPS TE reduccion 90 HHH 3/4X 1/2 X 3/4
 5000/373 IPS TE reduccion 90 HHH 3/4X1/2X1/2
 5000/370 IPS TE reduccion 90 HHH 1X1/2X1
 5000/369 IPS TE reduccion 90 HHH 1 X3/4X1



5000/390 IPS Cupla reduccion 1/2X3/8
 5000/389 IPS Cupla reduccion 3/4X3/8
 5000/398 IPS Cupla reduccion 3/4X1/2
 5000/400 IPS Cupla reduccion 1X1/2
 5000/399 IPS Cupla reduccion 1X3/4



5000/418 IPS Entrerosca reduccion 3/4X1/2
 5000/419 IPS Entrerosca reduccion 1X3/4
 5000/420 IPS Entrerosca reduccion 1X1/2



5000/598 IPS Cupla reduccion MH 1/2X3/4



5000/341 IPS Union doble 1/2
 5000/342 IPS union doble 3/4
 5000/343 IPS union doble 1
 5000/344 IPS union doble 1 1/4
 5000/345 IPS union doble 1 1/2
 5000/346 IPS union doble 2



5000/911 IPS Union doble MH 1/2
 5000/912 IPS Union doble MH 3/4
 5000/913 IPS Union doble MH 1



5000/421 IPS Buje MH 1/2X3/8
 5000/436 IPS Buje MH 3/4X3/8
 5000/422 IPS Buje MH 3/4X1/4
 5000/428 IPS Buje MH 3/4X1/2
 5000/430 IPS Buje MH 1X1/2
 5000/429 IPS Buje MH 1X3/4
 5000/438 IPS Buje MH 1 1/4X1/2
 5000/437 IPS Buje MH 1 1/4X3/4
 5000/432 IPS Buje MH 1 1/4X1
 5000/441 IPS Buje MH 1 1/2X1/2
 5000/440 IPS Buje MH 1 1/2X3/4
 5000/439 IPS Buje MH 1 1/2X1
 5000/433 IPS Buje MH 1 1/2X1 1/4
 5000/445 IPS Buje MH 2 X 1/2
 5000/444 IPS Buje MH 2 X3/4
 5000/443 IPS Buje MH 2 X 1
 5000/442 IPS Buje MH 2 X 1 1/4
 5000/434 IPS Buje MH 2 X 1 1/2
 5000/447 IPS Buje MH 2 1/2 X 1 1/2
 5000/435 IPS Buje MH 2 1/2 X 2



5000/1301 IPS Codo 90 c/inserto H 1/2
 5000/1302 IPS Codo 90 c/inserto H 3/4
 5000/1303 IPS Codo 90 c/inserto H 1
 5000/1308 IPS Codo 90 c/inserto H 3/4 x 1/2



5000/1322 IPS Codo 90 c/inserto M 3/4
 5000/1329 IPS Codo 90 c/inserto M 1



5000/1361 IPS Tee c/inserto H 1/2
 5000/1362 IPS Tee c/inserto H 3/4
 5000/1364 IPS Tee c/inserto H 1
 5000/1368 IPS Tee c/inserto H 3/4 x 1/2



5000/1391 IPS Cupla c/inserto H 1/2
 5000/1392 IPS Cupla c/inserto H 3/4
 5000/1393 IPS Cupla c/inserto H 1



5000/1399 IPS Cupla reduccion c/inserto H 1/2 x 3/8
 5000/1398 IPS Cupla reduccion c/inserto H 3/4 x 1/2
 5000/1394 IPS Cupla reduccion c/inserto H 1 x 3/4

5000/1591 IPS Cupla c/inserto M 1/2
 5000/1592 IPS Cupla c/inserto M 3/4

5000/1763 IPS Tee c/inserto M 1/2
 5000/1764 IPS Tee c/inserto M 3/4
 5000/1765 IPS Tee c/inserto M 1

5000/2301 IPS Codo con sujesion inserto H 1/2

5000/561 IPS Llave paso 1/2
 5000/562 IPS Llave paso 3/4
 5000/563 IPS Llave paso 1

5000/771 IPS Llave paso con campana 1/2
 5000/772 IPS Llave paso con campana 3/4



ACCESORIOS DE POLIETILENO

1040/01 Codo espiga espiga 1/2 polietileno
 1040/02 Codo espiga espiga 3/4 polietileno
 1040/03 Codo espiga espiga 1 polietileno
 1040/32 Codo espiga espiga 1 1/4 polietileno
 1040/33 Codo espiga espiga 1 1/2 polietileno
 1040/34 Codo espiga espiga 2 polietileno



1040/01A Codo espiga ROSCA MACHO 1/2 polietileno
 1040/02A Codo espiga ROSCA MACHO 3/4 polietileno
 1040/03A Codo espiga ROSCA MACHO 1 polietileno
 1040/61 Codo espiga ROSCA MACHO 1 1/4 polietileno
 1040/62 Codo espiga ROSCA MACHO 1 1/2 polietileno
 1040/63 Codo espiga ROSCA MACHO 2 polietileno



1040/04 Codo espiga rosca hembra 1/2 polietileno
 1040/05 Codo espiga rosca hembra 3/4 polietileno
 1040/06 Codo espiga rosca hembra 1 polietileno
 1040/35 Codo espiga rosca hembra 1 1/4 polietileno
 1040/36 Codo espiga rosca hembra 1 1/2 polietileno
 1040/37 Codo espiga rosca hembra 2 polietileno



1040/07 Espiga espiga 1/2 polietileno
 1040/08 Espiga espiga 3/4 polietileno
 1040/09 Espiga espiga 1 polietileno
 1040/38 Espiga espiga 1 1/4 polietileno
 1040/39 Espiga espiga 1 1/2 polietileno
 1040/40 Espiga espiga 2 polietileno



1040/10 Espiga espiga reduccion 3/4 x 1/2 polietileno
 1040/11 Espiga espiga reduccion 1 x 1/2 polietileno
 1040/12 Espiga espiga reduccion 1 x 3/4 polietileno
 1040/41 Espiga espiga reduccion 1 1/4 x 1 polietileno
 1040/42 Espiga espiga reduccion 1 1/2 x 1 1/4 polietileno
 1040/43 Espiga espiga reduccion 2 x 1 1/2 polietileno



1040/13 Espiga rosca hembra 1/2 polietileno
 1040/14 Espiga rosca hembra 3/4 polietileno
 1040/15 Espiga rosca hembra 1 polietileno
 1040/44 Espiga rosca hembra 1 1/4 polietileno
 1040/45 Espiga rosca hembra 1 1/2 polietileno
 1040/46 Espiga rosca hembra 2 polietileno



1040/16 Espiga 3/4 rosca hembra 1/2 polietileno
 1040/17 Espiga 1/2 rosca hembra 3/4 polietileno
 1040/18 Espiga 1/2 rosca hembra 1 polietileno
 1040/47 Espiga 3/4 rosca hembra 1 polietileno
 1040/59 Espiga 1 rosca hembra 1/2 polietileno
 1040/60 Espiga 1 rosca hembra 3/4 polietileno



1040/19 Espiga rosca macho 1/2 polietileno
 1040/20 Espiga rosca macho 3/4 polietileno
 1040/21 Espiga rosca macho 1 polietileno
 1040/48 Espiga rosca macho 1 1/4 polietileno
 1040/49 Espiga rosca macho 1 1/2 polietileno
 1040/50 Espiga rosca macho 2 polietileno



1040/22 Espiga 3/4 rosca macho 1/2 polietileno
 1040/23 Espiga 1/2 rosca macho 3/4 polietileno
 1040/24 Espiga 1/2 rosca macho 1 polietileno
 1040/25 Espiga 3/4 rosca macho 1 polietileno
 1040/57 Espiga 1 rosca macho 3/4 polietileno
 1040/58 Espiga 1 rosca macho 1/2 polietileno



1040/26 Tee espiga espiga 1/2 polietileno
 1040/27 Tee espiga espiga 3/4 polietileno
 1040/28 Tee espiga espiga 1 polietileno
 1040/51 Tee espiga espiga 1 1/4 polietileno
 1040/52 Tee espiga espiga 1 1/2 polietileno
 1040/53 Tee espiga espiga 2 polietileno



1040/29 Tee espiga rosca hembra 1/2 polietileno
 1040/30 Tee espiga rosca hembra 3/4 polietileno
 1040/31 Tee espiga rosca hembra 1 polietileno
 1040/54 Tee espiga rosca hembra 1 1/4 polietileno
 1040/55 Tee espiga rosca hembra 1 1/2 polietileno
 1040/56 Tee espiga rosca hembra 2 polietileno



ACCESORIOS DE TERMOFUSION (FUSIONAR)

1050/01 Boquilla 20 mm
 1050/02 Boquilla 25 mm
 1050/03 Boquilla 32 mm



1050/03a Buje 25 x 20
1050/03b Buje 32 x 20
1050/03c Buje 32 x 25



1050/04 Codo 20 mm
1050/05 Codo 25 mm
1050/06 Codo 32 mm



1050/07 Codo 45° 20 mm
1050/08 Codo 45° 25 mm
1050/09 Codo 45° 32 mm



1050/170 Codo reduccion 25 x 20
1050/171 Codo reduccion 32 x 25



1050/10 Codo c/inserto metalico hembra 1/2 x 20 mm
1050/11 Codo c/inserto metalico hembra 3/4 x 20 mm
1050/12 Codo c/inserto metalico hembra 1/2 x 25 mm
1050/13 Codo c/inserto metalico hembra 3/4 x 25 mm
1050/14 Codo c/inserto metalico hembra 3/4 x 32 mm
1050/15 Codo c/inserto metalico hembra 1 x 32 mm



1050/16 Codo c/inserto metalico macho 1/2 x 20 mm
1050/17 Codo c/inserto metalico macho 1/2 x 25 mm
1050/18 Codo c/inserto metalico macho 3/4 x 25 mm
1050/19 Codo c/inserto metalico macho 1 x 32 mm



1050/200 Conexión tanque 20 mm
1050/201 Conexión tanque 25 mm
1050/202 Conexión tanque 32 mm
1050/203 Conexión tanque 40 mm



1050/20 Cupla 20 mm
1050/21 Cupla 25 mm
1050/22 Cupla 32 mm



1050/23 Cupla c/inserto metalico hembra 3/8 x 20 mm
1050/24 Cupla c/inserto metalico hembra 1/2 x 20 mm
1050/25 Cupla c/inserto metalico hembra 1/2 x 25 mm
1050/25B Cupla c/inserto metalico hembra 20 x 3/4 mm
1050/26 Cupla c/inserto metalico hembra 3/4 x 25 mm
1050/26B Cupla c/inserto metalico hembra 3/4 x 32 mm
1050/27 Cupla c/inserto metalico hembra 1 x 32 mm



1050/28 Cupla c/inserto metalico macho 1/2 x 20 mm
1050/29 Cupla c/inserto metalico macho 1/2 x 25 mm
1050/29A Cupla c/inserto metalico macho 3/4 x 20 mm
1050/30 Cupla c/inserto metalico macho 3/4 x 25 mm
1050/31 Cupla c/inserto metalico macho 3/4 x 32 mm
1050/32 Cupla c/inserto metalico macho 1 x 32 mm



1050/33 Cupla reduccion 25 mm x 20 mm
1050/34 Cupla reduccion 32 mm x 20 mm
1050/35 Cupla reduccion 32 mm x 25 mm



1050/07B Curva 90 20 mm
1050/08B Curva 90 25 mm
1050/09B Curva 90 32 mm



1050/36 Sobrepaso largo 20 mm
1050/37 Sobrepaso largo 25 mm
1050/38 Sobrepaso largo 32 mm



1050/160 Sobrepaso corto 20 mm
1050/161 Sobrepaso corto 25 mm
1050/162 Sobrepaso corto 32 mm



1050/39 Tapa 20 mm
1050/40 Tapa 25 mm
1050/41 Tapa 32 mm



1050/42 Tee 20 mm
1050/43 Tee 25 mm
1050/44 Tee 32 mm



1050/45 Tee c/inserto metalico hembra 1/2 x 20 mm
1050/46 Tee c/inserto metalico hembra 1/2 x 25 mm
1050/47 Tee c/inserto metalico hembra 3/4 x 25 mm
1050/48 Tee c/inserto metalico hembra 3/4 x 32 mm
1050/49 Tee c/inserto metalico hembra 1 x 32 mm



1050/50 Tee c/inserto metalico macho 1/2 x 20 mm
1050/51 Tee c/inserto metalico macho 1/2 x 25 mm
1050/52 Tee c/inserto metalico macho 3/4 x 25 mm
1050/53 Tee c/inserto metalico macho 3/4 x 32 mm
1050/54 Tee c/inserto metalico macho 1 x 32 mm



1050/55 Tee reduccion 25 mm x 20 mm
1050/55A Tee reduccion 32 mm x 20 mm
1050/55B Tee reduccion 32 mm x 25 mm



1050/56 Union doble c/inserto metalico hembra 1/2 x 20 mm
1050/57 Union doble c/inserto metalico hembra 3/4 x 25 mm
1050/58 Union doble c/inserto metalico hembra 1 x 32 mm



1050/59 Union doble c/inserto metalico macho 1/2 x 20 mm
1050/60 Union doble c/inserto metalico macho 3/4 x 25 mm
1050/61 Union doble c/inserto metalico macho 1 x 32 mm



- 1050/62 Union doble fusion fusion 20 mm
- 1050/63 Union doble fusion fusion 25 mm
- 1050/64 Union doble fusion fusion 32 mm



ACCESORIOS IPS TERMOFUSION

- 5000/2901 IPS Caño fusion 20
- 5000/2902 IPS Caño fusion 25
- 5000/2903 IPS Caño fusion 32
- 5000/2904 IPS Caño fusion 40
- 5000/2905 IPS Caño fusion 50
- 5000/2906 IPS Caño fusion 63



- 5000/2921 IPS Caño maxum fusion 20
- 5000/2922 IPS Caño maxum fusion 25
- 5000/2923 IPS Caño maxum fusion 32
- 5000/2924 IPS Caño maxum fusion 40
- 5000/2925 IPS Caño maxum fusion 50
- 5000/2926 IPS Caño maxum fusion 63



- 5000/101 IPS Codo 90° 20
- 5000/102 IPS Codo 90° 25
- 5000/103 IPS Codo 90° 32
- 5000/104 IPS Codo 90° 40
- 5000/105 IPS Codo 90° 50
- 5000/106 IPS Codo 90° 63



- 5000/111 IPS Tapa 20
- 5000/112 IPS Tapa 25
- 5000/113 IPS Tapa 32
- 5000/114 IPS Tapa 40
- 5000/115 IPS Tapa 50
- 5000/116 IPS Tapa 63



- 5000/121 IPS Codo 90° MH 20
- 5000/122 IPS Codo 90° MH 25
- 5000/123 IPS Codo 90° MH 32



5000/131 IPS Codo 45° 20
5000/132 IPS Codo 45° 25
5000/133 IPS Codo 45° 32
5000/134 IPS Codo 45° 40
5000/135 IPS Codo 45° 50
5000/136 IPS Codo 45° 63



5000/161 IPS Tee 20
5000/162 IPS Tee 25
5000/163 IPS Tee 32
5000/164 IPS Tee 40
5000/165 IPS Tee 50
5000/166 IPS Tee 63



5000/191 IPS Cupla 20
5000/192 IPS Cupla 25
5000/193 IPS Cupla 32
5000/194 IPS Cupla 40
5000/195 IPS Cupla 50
5000/196 IPS Cupla 63



5000/281 IPS Curva 90° 20
5000/282 IPS Curva 90° 25
5000/283 IPS Curva 90° 32
5000/284B IPS Curva 90° 40
5000/285 IPS Curva 90° 50
5000/286 IPS Curva 90° 63



5000/291 IPS Sobrepasso largo 20
5000/292 IPS Sobrepasso largo 25
5000/293 IPS Sobrepasso largo 32



5000/1291 IPS Sobrepasso corto 20
5000/1292 IPS Sobrepasso corto 25
5000/1293 IPS Sobrepasso corto 32



5000/1241 IPS Misturador 20
5000/1242 IPS Misturador 25



5000/721 IPS Adaptador para tanque 20
 5000/722 IPS Adaptador para tanque 25
 5000/723 IPS Adaptador para tanque 32
 5000/724 IPS Adaptador para tanque 40



5000/751 IPS Cruz 20
 5000/752 IPS Cruz 25
 5000/753 IPS Cruz 32



5000/1211 IPS Codo esquinero 90° 20
 5000/1212 IPS Codo esquinero 90° 25
 5000/1213 IPS Codo esquinero 90° 32

5000/140 IPS Buje reduccion 25 x 20
 5000/141 IPS Buje reduccion 32 x 20
 5000/142 IPS Buje reduccion 32 x 25
 5000/143 IPS Buje reduccion 40 x 20
 5000/144 IPS Buje reduccion 40 x 25
 5000/145 IPS Buje reduccion 40 x 32
 5000/146 IPS Buje reduccion 50 x 20
 5000/148 IPS Buje reduccion 50 x 25
 5000/149 IPS Buje reduccion 50 x 32
 5000/150 IPS Buje reduccion 50 x 40
 5000/151 IPS Buje reduccion 63 x 20
 5000/152 IPS Buje reduccion 63 x 25
 5000/153 IPS Buje reduccion 63 x 32
 5000/154 IPS Buje reduccion 63 x 40
 5000/155 IPS Buje reduccion 63 x 50



5000/1220 IPS Codo reduccion 90° 25 x 20
 5000/1221 IPS Codo reduccion 90° 32 x 20
 5000/1222 IPS Codo reduccion 90° 32 x 25



5000/241 IPS Tee reduccion 25 x 20
 5000/242 IPS Tee reduccion 32 x 20
 5000/243 IPS Tee reduccion 32 x 25
 5000/244 IPS Tee reduccion 40 x 20
 5000/245 IPS Tee reduccion 40 x 25
 5000/246 IPS Tee reduccion 40 x 32
 5000/247 IPS Tee reduccion 50 x 20
 5000/248 IPS Tee reduccion 50 x 25
 5000/249 IPS Tee reduccion 50 x 32
 5000/250 IPS Tee reduccion 50 x 40
 5000/251 IPS Tee reduccion 63 x 20
 5000/252 IPS Tee reduccion 63 x 25
 5000/253 IPS Tee reduccion 63 x 32
 5000/254 IPS Tee reduccion 63 x 40
 5000/257 IPS Tee reduccion 63 x 50



5000/1752 IPS Colector 4 bajadas 32 x 25
 5000/1757 IPS Colector 4 bajadas 75 x 63



5000/200 IPS Codo 90° c/inserto H 20 x 3/8
 5000/201 IPS Codo 90° c/inserto H 20 x 1/2
 5000/202 IPS Codo 90° c/inserto H 25 x 1/2
 5000/203 IPS Codo 90° c/inserto H 25 x 3/4
 5000/204 IPS Codo 90° c/inserto H 32 x 1
 5000/205 IPS Codo 90° c/inserto H 25 x 3/8
 5000/209 IPS Codo 90° c/inserto H 32 x 3/4



5000/219 IPS Cupla c/inserto M 32 x 1/2
 5000/220 IPS Cupla c/inserto M 25 x 1/2
 5000/221 IPS Cupla c/inserto M 20 x 1/2
 5000/222 IPS Cupla c/inserto M 25 x 3/4
 5000/223 IPS Cupla c/inserto M 32 x 1
 5000/224 IPS Cupla c/inserto M 40 x 1 1/4
 5000/225 IPS Cupla c/inserto M 50 x 1 1/2
 5000/226 IPS Cupla c/inserto M 63 x 2



5000/210 IPS Tee c/inserto H 20 x 3/8
 5000/211 IPS Tee c/inserto H 20 x 1/2
 5000/212 IPS Tee c/inserto H 25 x 1/2
 5000/213 IPS Tee c/inserto H 25 x 3/4
 5000/214 IPS Tee c/inserto H 32 x 1



5000/270 IPS Cupla c/inserto H 20 x 3/8
 5000/271 IPS Cupla c/inserto H 20 x 1/2
 5000/272 IPS Cupla c/inserto H 25 x 3/4
 5000/273 IPS Cupla c/inserto H 32 x 1
 5000/274 IPS Cupla c/inserto H 40 x 1 1/4
 5000/275 IPS Cupla c/inserto H 50 x 1 1/2
 5000/276 IPS Cupla c/inserto H 63 x 2
 5000/278 IPS Cupla c/inserto H 25 x 1/2
 5000/279 IPS Cupla c/inserto H 32 x 3/4
 5000/284 IPS Cupla c/inserto H 32 x 1/2
 5000/290 IPS Cupla c/inserto H 20 x 3/4



5000/761 IPS Tee c/inserto M 20 x 1/2
 5000/763 IPS Tee c/inserto M 25 x 3/4
 5000/764 IPS Tee c/inserto M 32 x 1
 5000/769 IPS Tee c/inserto M 32 x 3/4



5000/1121 IPS Codo 90° c/inserto M 20 x 1/2
 5000/1122 IPS Codo 90° c/inserto M 25 x 1/2
 5000/1123 IPS Codo 90° c/inserto M 25 x 3/4
 5000/1129 IPS Codo 90° c/inserto M 32 x 3/4
 5000/229 IPS Codo 90° c/inserto M 32 x 1



5000/1201 IPS Cdo 90° c/sujecion RH 20 x 1/2



5000/1920 IPS Misturador RH 3/4 x 25 x 3/4



- 5000/231 IPS Union doble 20
- 5000/232 IPS Union doble 25
- 5000/233 IPS Union doble 32
- 5000/234 IPS Union doble 40
- 5000/235 IPS Union doble 50
- 5000/236 IPS Union doble 63



- 5000/531 IPS Union doble RH 20 x 1/2
- 5000/532 IPS Union doble RH 25 x 3/4
- 5000/533 IPS Union doble RH 32 x 1
- 5000/534 IPS Union doble RH 40 x 1 1/4
- 5000/535 IPS Union doble RH 50 x 1 1/2
- 5000/536 IPS Union doble RH 63 x 2



- 5000/921 IPS Union doble RM 20 x 1/2
- 5000/922 IPS Union doble RM 25 x 3/4
- 5000/923 IPS Union doble RM 32 x 1



- 5000/171 IPS Llave paso volante blanco 20
- 5000/172 IPS Llave paso volante blanco 25
- 5000/173 IPS Llave paso volante blanco 32



- 5000/181 IPS Llave paso volante cromado 20
- 5000/182 IPS Llave paso volante cromado 25



- 5000/1801 IPS Llave paso c/c cabezal metalico 20
- 5000/1802 IPS Llave paso c/c cabezal metalico 25
- 5000/1803 IPS Llave paso c/c cabezal metalico 32



5000/1901 IPS Llave esferica manija corta 20
5000/1902 IPS Llave esferica manija corta 25



5000/1951 IPS Llave esferica manija larga 20
5000/1952 IPS Llave esferica manija larga 25
5000/1953 IPS Llave esferica manija larga 32
5000/1914 IPS Llave esferica manija larga 40
5000/1915 IPS Llave esferica manija larga 50



5000/1961 IPS Llave esferica c/c y volante ABS 20
5000/1962 IPS Llave esferica c/c y volante ABS 25
5000/1963 IPS Llave esferica c/c y volante ABS 32



5000/1971 IPS Llave esferica c/c y volante metal 20
5000/1972 IPS Llave esferica c/c y volante metal 25
5000/1973 IPS Llave esferica c/c y volante metal 32



5000/1981 IPS Llave esferica c/media union 20
5000/1982 IPS Llave esferica c/media union 25

ACCESORIOS REDECO TERMOFUSION

1700/01	Caño 20 mm Redeco PN20
1700/02	Caño 25 mm Redeco PN20
1700/03	Caño 32 mm Redeco PN20
1700/04	Caño 40 mm Redeco PN20
1700/05	Caño 50 mm Redeco PN20
1700/06	Caño 63 mm Redeco PN20
1700/07	Caño 75 mm Redeco PN20



1700/08	Cupla 20 mm Redeco
1700/09	Cupla 25 mm Redeco
1700/10	Cupla 32 mm Redeco
1700/11	Cupla 40 mm Redeco
1700/12	Cupla 50 mm Redeco
1700/13	Cupla 63 mm Redeco
1700/14	Cupla 75 mm Redeco



1700/15	Codo 20 mm Redeco
1700/16	Codo 25 mm Redeco
1700/17	Codo 32 mm Redeco
1700/18	Codo 40 mm Redeco
1700/19	Codo 50 mm Redeco
1700/20	Codo 63 mm Redeco
1700/21	Codo 75 mm Redeco



1700/22	Tee 20 mm Redeco
1700/23	Tee 25 mm Redeco
1700/24	Tee 32 mm Redeco
1700/25	Tee 40 mm Redeco
1700/26	Tee 50 mm Redeco
1700/27	Tee 63 mm Redeco
1700/28	Tee 75 mm Redeco



1700/29 Tee reducc. Central 25 x 20 mm Redeco
 1700/30 Tee reducc. Central 32 x 20 mm Redeco
 1700/31 Tee reducc. Central 32 x 25 mm Redeco
 1700/32 Tee reducc. Central 40 x 25 mm Redeco
 1700/33 Tee reducc. Central 40 x 32 mm Redeco
 1700/34 Tee reducc. Central 50 x 32 mm Redeco
 1700/35 Tee reducc. Central 50 x 40 mm Redeco
 1700/36 Tee reducc. Central 63 x 40 mm Redeco
 1700/37 Tee reducc. Central 63 x 50 mm Redeco



1700/38 Cupla reducc. 25 x 20 mm Redeco
 1700/39 Cupla reducc. 32 x 20 mm Redeco
 1700/40 Cupla reducc. 32 x 25 mm Redeco
 1700/41 Cupla reducc. 40 x 25 mm Redeco
 1700/42 Cupla reducc. 40 x 32 mm Redeco
 1700/43 Cupla reducc. 50 x 32 mm Redeco
 1700/44 Cupla reducc. 50 x 40 mm Redeco
 1700/45 Cupla reducc. 63 x 40 mm Redeco
 1700/46 Cupla reducc. 63 x 50 mm Redeco



1700/47 Buje reducc. 25 x 20 mm Redeco
 1700/48 Buje reducc. 32 x 20 mm Redeco
 1700/49 Buje reducc. 32 x 25 mm Redeco
 1700/50 Buje reducc. 40 x 25 mm Redeco
 1700/51 Buje reducc. 40 x 32 mm Redeco
 1700/52 Buje reducc. 50 x 32 mm Redeco
 1700/53 Buje reducc. 50 x 40 mm Redeco
 1700/54 Buje reducc. 63 x 40 mm Redeco
 1700/55 Buje reducc. 63 x 50 mm Redeco
 1700/56 Buje reducc. 75 x 63 mm Redeco



1700/57 Tapa 20 mm Redeco
 1700/58 Tapa 25 mm Redeco
 1700/59 Tapa 32 mm Redeco
 1700/60 Tapa 40 mm Redeco
 1700/61 Tapa 50 mm Redeco
 1700/62 Tapa 63 mm Redeco
 1700/63 Tapa 75 mm Redeco



1700/64	Sobrepaso largo 20 mm Redeco
1700/65	Sobrepaso largo 25 mm Redeco
1700/66	Sobrepaso largo 32 mm Redeco
1700/67	Sobrepaso corto 20 mm Redeco
1700/68	Sobrepaso corto 25 mm Redeco
1700/69	Curva 90° 20 mm Redeco
1700/70	Curva 90° 25 mm Redeco
1700/71	Curva 90° 32 mm Redeco
1700/72	Codo 45° 20 mm Redeco
1700/73	Codo 45° 25 mm Redeco
1700/74	Codo 45° 32 mm Redeco
1700/75	Union doble 20 mm Redeco
1700/76	Union doble 25 mm Redeco
1700/77	Union doble 32 mm Redeco
1700/78	Union doble con brida 40 Redeco
1700/79	Union doble con brida 50 Redeco
1700/80	Union doble con brida 63 Redeco
1700/81	Union doble con brida 75 Redeco



ACCESORIOS REDECO TERMOFUSION C/INSERTO METALICO

1700/82	Codo 90° RH 20 x 1/2 Redeco
1700/83	Codo 90° RH 25 x 1/2 Redeco
1700/84	Codo 90° RH 25 x 3/4 Redeco
1700/85	Codo 90° RH 32 x 3/4 Redeco
1700/86	Codo 90° RH 32 x 1 Redeco
1700/87	Codo 90° RM 20 x 1/2 Redeco
1700/88	Codo 90° RM 25 x 1/2 Redeco
1700/89	Codo 90° RM 25 x 3/4 Redeco
1700/90	Codo 90° RM 32 x 3/4 Redeco
1700/91	Codo 90° RM 32 x 1 Redeco



1700/92 Cupla RH 20 x 3/8 Redeco
 1700/93 Cupla RH 20 x 1/2 Redeco
 1700/94 Cupla RH 20 x 3/4 Redeco
 1700/95 Cupla RH 25 x 1/2 Redeco
 1700/96 Cupla RH 25 x 3/4 Redeco
 1700/97 Cupla RH 32 x 3/4 Redeco
 1700/98 Cupla RH 32 x 1 Redeco
 1700/99 Cupla RH 40 x 1 1/4 Redeco
 1700/100 Cupla RH 50 x 1 1/2 Redeco
 1700/101 Cupla RH 63 x 2 Redeco
 1700/102 Cupla RH 75 x 2 1/2 Redeco



1700/103 Tubo RM 20 x 1/2 Redeco
 1700/104 Tubo RM 20 x 3/4 Redeco
 1700/105 Tubo RM 25 x 1/2 Redeco
 1700/106 Tubo RM 25 x 3/4 Redeco
 1700/107 Tubo RM 32 x 3/4 Redeco
 1700/108 Tubo RM 32 x 1 Redeco
 1700/109 Tubo RM 40 x 1 1/4 Redeco
 1700/110 Tubo RM 50 x 1 1/2 Redeco
 1700/111 Tubo RM 63 x 2 Redeco
 1700/112 Tubo RM 75 x 2 1/2 Redeco



1700/113 Tee RH 20 x 1/2 Redeco
 1700/114 Tee RH 25 x 1/2 Redeco
 1700/115 Tee RH 25 x 3/4 Redeco
 1700/116 Tee RH 32 x 3/4 Redeco
 1700/117 Tee RH 32 x 1 Redeco



1700/118 Tee RM 20 x 1/2 Redeco
 1700/119 Tee RM 25 x 1/2 Redeco
 1700/120 Tee RM 25 x 3/4 Redeco
 1700/121 Tee RM 32 x 3/4 Redeco
 1700/122 Tee RM 32 x 1 Redeco



1700/123 Union doble RH 20 x 1/2 Redeco
 1700/124 Union doble RH 25 x 3/4 Redeco
 1700/125 Union doble RH 32 x 1 Redeco



- 1700/126 Union doble RM 20 x 1/2 Redeco
- 1700/127 Union doble RM 25 x 3/4 Redeco
- 1700/128 Union doble RM 32 x 1 Redeco



LLAVES DE PASO REDECO TERMOFUSION



- 1700/129 Llave paso 20 mm c/campana cabezal plastico
- 1700/130 Llave paso 25 mm c/campana cabezal plastico
- 1700/131 Llave paso 32 mm c/campana cabezal plastico



- 1700/132 Llave paso 20 mm c/campana cabezal bronce
- 1700/133 Llave paso 25 mm c/campana cabezal bronce
- 1700/134 Llave paso 32 mm c/campana cabezal bronce



- 1700/135 Llave paso esferica 20 mm plastica
- 1700/136 Llave paso esferica 25 mm plastica
- 1700/137 Llave paso esferica 32 mm plastica

- 1700/138 Llave paso esferica 20 mm manija metal
- 1700/139 Llave paso esferica 25 mm manija metal
- 1700/140 Llave paso esferica 32 mm manija metal
- 1700/141 Llave paso esferica 40 mm manija metal



ACCESORIOS TERMOFUSION GAS IPS (VANTEC)

5000/42911 VANTEC Caño 20
 5000/42912 VANTEC Caño 25
 5000/42913 VANTEC Caño 32
 5000/42914 VANTEC Caño 40
 5000/42915 VANTEC Caño 50



5000/44101 VANTEC Codo 90° 20
 5000/44102 VANTEC Codo 90° 25
 5000/44103 VANTEC Codo 90° 32
 5000/44104 VANTEC Codo 90° 40
 5000/44105 VANTEC Codo 90° 50



5000/44111 VANTEC Tapa 20
 5000/44112 VANTEC Tapa 25
 5000/44113 VANTEC Tapa 32
 5000/44114 VANTEC Tapa 40
 5000/44115 VANTEC Tapa 50



5000/44131 VANTEC Codo 45° 20
 5000/44132 VANTEC Codo 45° 25
 5000/44133 VANTEC Codo 45° 32
 5000/44134 VANTEC Codo 45° 40
 5000/44135 VANTEC Codo 45° 50



5000/44140 VANTEC Cupla reduccion 25 x 20
 5000/44141 VANTEC Cupla reduccion 32 x 20
 5000/44142 VANTEC Cupla reduccion 32 x 25



5000/44161 VANTEC Tee 20
 5000/44162 VANTEC Tee 25
 5000/44163 VANTEC Tee 32
 5000/44164 VANTEC Tee 40
 5000/44165 VANTEC Tee 50



5000/44191 VANTEC Cupla 20
 5000/44192 VANTEC Cupla 25
 5000/44193 VANTEC Cupla 32
 5000/44194 VANTEC Cupla 40
 5000/44195 VANTEC Cupla 50



5000/44201 VANTEC Codo 90° RH 20 x 1/2
 5000/44202 VANTEC Codo 90° RH 25 x 1/2
 5000/44203 VANTEC Codo 90° RH 25 x 3/4
 5000/44204 VANTEC Codo 90° RH 32 x 3/4
 5000/44205 VANTEC Codo 90° RH 32 x 1
 5000/44206 VANTEC Codo 90° RH 40 x 1 1/4
 5000/44207 VANTEC Codo 90° RH 50 x 1 1/2



5000/44221 VANTEC Cupla RM 20 x 1/2
 5000/44222 VANTEC Cupla RM 25 x 1/2
 5000/44223 VANTEC Cupla RM 25 x 3/4
 5000/44224 VANTEC Cupla RM 32 x 1
 5000/44225 VANTEC Cupla RM 40 x 1 1/4
 5000/44226 VANTEC Cupla RM 50 x 1 1/2



5000/44241 VANTEC Tee reduccion 25 x 20
 5000/44242 VANTEC Tee reduccion 32 x 20
 5000/44243 VANTEC Tee reduccion 32 x 25



5000/44271 VANTEC Cupla RH 20 x 1/2
 5000/44272 VANTEC Cupla RH 25 x 1/2
 5000/44273 VANTEC Cupla RH 25 x 3/4
 5000/44274 VANTEC Cupla RH 32 x 1
 5000/44275 VANTEC Cupla RH 40 x 1 1/4
 5000/44276 VANTEC Cupla RH 50 x 1 1/2



5000/44421 VANTEC Buje reduccion 40 x 25
 5000/44422 VANTEC Buje reduccion 40 x 32
 5000/44423 VANTEC Buje reduccion 50 x 32
 5000/44424 VANTEC Buje reduccion 50 x 40



- 5000/44291 VANTEC Sobrepaso 20
- 5000/44292 VANTEC Sobrepaso 25
- 5000/44293 VANTEC Sobrepaso 32

- 5000/44931 VANTEC Llave paso 20 c/campana
- 5000/44932 VANTEC Llave paso 25 c/campana
- 5000/44933 VANTEC Llave paso 32 c/campana

- 5000/44841 VANTEC Montura reparacion 20
- 5000/44842 VANTEC Montura reparacion 25
- 5000/44843 VANTEC Montura reparacion 32



ACCESORIOS PVC LINEA 100 (COMUN)

1050/65 CAÑO CAMARA 100



1050/66 CODO 40

1050/67 CODO 50

1050/68 CODO 60

1050/69 CODO 100



1050/70 CODO CON BASE 100



1050/71 CODO CON ACOMETIDA 100



1050/153 CODO MH 40



1050/72 CUPLA 40
1050/73 CUPLA 50
1050/74 CUPLA 60
1050/75 CUPLA 100



1050/76 CURVA 90 DE 40
1050/77 CURVA 90 DE 50
1050/78 CURVA 90 DE 60
1050/79 CURVA 90 DE 100



1050/80 CURVA 45 DE 40
1050/81 CURVA 45 DE 50
1050/82 CURVA 45 DE 60
1050/83 CURVA 45 DE 100



1050/84 PILETA PATIO 10 X 10
1050/85 PILETA PATIO 15 X 15



1050/86 BOCA ACCESO COCINA



1050/87 RECEPTACULO DE DUCHA



1050/88 REDUCCION 50 X 40
1050/89 REDUCCION 60 X 40
1050/90 REDUCCION 60 X 50
1050/91 REDUCCION 100 X 60



1050/92 TAPA 40
1050/93 TAPA 50
1050/94 TAPA 60
1050/95 TAPA 100

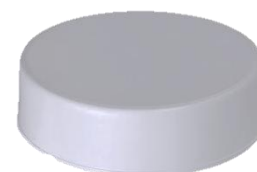

1050/96 RAMAL 90 DE 40
 1050/97 RAMAL 90 DE 50
 1050/98 RAMAL 90 DE 60
 1050/99 RAMAL 90 DE 100
 1050/100 RAMAL 90 DE 100 X 60



1050/101 RAMAL 45 DE 40
 1050/102 RAMAL 45 DE 50
 1050/103 RAMAL 45 DE 60
 1050/104 RAMAL 45 DE 100
 1050/105 RAMAL 45 DE 100 X 60



1050/106 EMBUDO VERTICAL 60
 1050/107 EMBUDO VERTICAL 100



1050/108 EMBUDO FRONTAL 60
 1050/109 EMBUDO FRONTAL 100



ACCESORIOS PVC LINEA 110 (REFORZADO)

1050/110 CAÑO CAMARA 110



1050/113 CODO 63
 1050/114 CODO 110



1050/115 CODO CON BASE 110



1050/116 CODO CON ACOMETIDA 110



1050/119
1050/120

CUPLA 63
CUPLA 110



1050/123
1050/124

CURVA 90 DE 63
CURVA 90 DE 110



1050/127
1050/128

CURVA 45 DE 63
CURVA 45 DE 110 larga



1050/129

DESENGRASADORA 2 BOCAS



1050/130

DESENGRASADORA 3 BOCAS



1050/131
1050/132
1050/133
1050/134
1050/154
1050/155
1050/156
1050/157

REDUCCION 63 X 40
REDUCCION 63 X 50
REDUCCION 110 X 63
REDUCCION 110 X 100
REDUCCION 110 X 98
REDUCCION 125 X 110
REDUCCION 140 X 110
REDUCCION 160 X 110



1050/135
1050/136

TAPA 63
TAPA 110

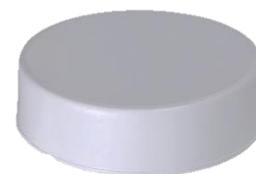

1050/137
1050/138

SOMBRERO 60/63
SOMBRERO 100/110



1050/141 RAMAL 90 DE 63
 1050/142 RAMAL 90 DE 110
 1050/143 RAMAL 90 DE 110 X 63



1050/146 RAMAL 45 DE 63
 1050/147 RAMAL 45 DE 110
 1050/148 RAMAL 45 DE 110 X 63



1050/149 EMBUDO VERTICAL 63
 1050/150 EMBUDO VERTICAL 110



1050/151 EMBUDO FRONTAL 63
 1050/152 EMBUDO FRONTAL 110



ACCESORIOS Y CAÑOS IPS DESAGUE

5000/50501 IPS Desague CAÑO 40 X 0,50 MTS
 5000/51001 IPS Desague CAÑO 40 X 1,00 MTS
 5000/52001 IPS Desague CAÑO 40 X 2,00 MTS
 5000/54001 IPS Desague CAÑO 40 X 4,00 MTS
 5000/50502 IPS Desague CAÑO 50 X 0,50 MTS
 5000/51002 IPS Desague CAÑO 50 X 1,00 MTS
 5000/52002 IPS Desague CAÑO 50 X 2,00 MTS
 5000/54002 IPS Desague CAÑO 50 X 4,00 MTS
 5000/50503 IPS Desague CAÑO 63 X 0,50 MTS
 5000/51003 IPS Desague CAÑO 63 X 1,00 MTS
 5000/52003 IPS Desague CAÑO 63 X 2,00 MTS
 5000/54003 IPS Desague CAÑO 63 X 4,00 MTS
 5000/50506 IPS Desague CAÑO 110 X 0,50 MTS
 5000/51006 IPS Desague CAÑO 110 X 1,00 MTS
 5000/52006 IPS Desague CAÑO 110 X 2,00 MTS
 5000/54006 IPS Desague CAÑO 110 X 4,00 MTS



5000/55301 IPS Desague Codo MH 45° 40
5000/55302 IPS Desague Codo MH 45° 50
5000/55303 IPS Desague Codo MH 45° 63
5000/55306 IPS Desague Codo MH 45° 110



5000/55311 IPS Desague Codo MH 90° 40
5000/55312 IPS Desague Codo MH 90° 50
5000/55313 IPS Desague Codo MH 90° 63
5000/55316 IPS Desague Codo MH 90° 110



5000/55321 IPS Desague Codo HH 45° 40
5000/55322 IPS Desague Codo HH 45° 50
5000/55323 IPS Desague Codo HH 45° 63
5000/55326 IPS Desague Codo HH 45° 110



5000/55331 IPS Desague Codo HH 90° 40
5000/55332 IPS Desague Codo HH 90° 50
5000/55333 IPS Desague Codo HH 90° 63
5000/55336 IPS Desague Codo HH 90° 110



5000/55346 IPS Desague Codo c/base MH 110



5000/55416 IPS Desague Curva HH 110



5000/55417 IPS Desague Curva MH 110



5000/55426 IPS Desague Curva c/base MH 110



5000/55427 IPS Desague Curva c/base HH 110



5000/55431 IPS Desague Manguito 40

5000/55432 IPS Desague Manguito 50

5000/55433 IPS Desague Manguito 63

5000/55436 IPS Desague Manguito 110



5000/55451 IPS Desague Cupla reduccion 50 x 40

5000/55450 IPS Desague Cupla reduccion 63 x 40

5000/55452 IPS Desague Cupla reduccion 63 x 50

5000/55453 IPS Desague Cupla reduccion 110 x 63



5000/55656 IPS Desague Caño camara 110



5000/55971 IPS Desague Manguito valvula inodoro 38 x 40



5000/55691 IPS Desague Tapon M 40

5000/55692 IPS Desague Tapon M 50

5000/55693 IPS Desague Tapon M 63

5000/55696 IPS Desague Tapon M 110



5000/55701 IPS Desague Tapa H 40

5000/55702 IPS Desague Tapa H 50

5000/55703 IPS Desague Tapa H 63

5000/55706 IPS Desague Tapa H 110



5000/55721 IPS Desague Codo 90° c/acometida der. 110 x 63
5000/55722 IPS Desague Codo 90° c/acometida izq. 110 x 63



5000/55723 IPS Desague Codo 90° doble acometida 110 x 63



5000/55724 IPS Desague Codo 90° triple acometida 110 x 63



5000/55715 IPS Desague Boca acceso cocina



5000/55751 IPS Desague Pileta ducha 40



5000/55753 IPS Desague Pileta balcon 63



5000/55774 IPS Desague Pileta patio 3 entrada HH

5000/55776 IPS Desague Pileta patio 3 entrada MH



5000/55775 IPS Desague Pileta patio 5 entradas HH

5000/55777 IPS Desague Pileta patio 5 entradas MH



5000/55970 IPS Desague Sifon pileta patio



5000/55900 IPS Desague Marco porta rejilla



5000/55920 IPS Desague Marco porta rejilla largo 10 x 10

5000/55921 IPS Desague Marco porta rejilla largo 12 x 12



5000/55770 IPS Desague Rejilla antiplaga 110



5000/55981 IPS Desague Adaptador desa. aire acon 40 x 3/4



5000/55471 IPS Desague Ramal 90° MH 40

5000/55472 IPS Desague Ramal 90° MH 50

5000/55473 IPS Desague Ramal 90° MH 63

5000/55476 IPS Desague Ramal 90° MH 110



5000/55484 IPS Desague Ramal reduc. 90° MH 63 x 40

5000/55485 IPS Desague Ramal reduc. 90° MH 63 x 50

5000/55481 IPS Desague Ramal reduc. 90° MH 110 x 50

5000/55482 IPS Desague Ramal reduc. 90° MH 110 x 63



5000/55491 IPS Desague Ramal 90° HH 40

5000/55492 IPS Desague Ramal 90° HH 50

5000/55493 IPS Desague Ramal 90° HH 63

5000/55496 IPS Desague Ramal 90° HH 110



5000/55811 IPS Desague Ramal reduc. 90° HH 63 x 40
5000/55812 IPS Desague Ramal reduc. 90° HH 63 x 50
5000/55813 IPS Desague Ramal reduc. 90° HH 110 x 50
5000/55814 IPS Desague Ramal reduc. 90° HH 110 x 63



5000/55511 IPS Desague Ramal 45° MH 40
5000/55512 IPS Desague Ramal 45° MH 50
5000/55513 IPS Desague Ramal 45° MH 63
5000/55516 IPS Desague Ramal 45° MH 110



5000/55524 IPS Desague Ramal reduc. 45° MH 63 x 40
5000/55521 IPS Desague Ramal reduc. 45° MH 63 x 50
5000/55525 IPS Desague Ramal reduc. 45° MH 110 x 50
5000/55522 IPS Desague Ramal reduc. 45° MH 110 x 63



5000/55531 IPS Desague Ramal 45° HH 40
5000/55532 IPS Desague Ramal 45° HH 50
5000/55533 IPS Desague Ramal 45° HH 63
5000/55536 IPS Desague Ramal 45° HH 110



5000/55526 IPS Desague Ramal reduc. 45° HH 63 x 40
5000/55527 IPS Desague Ramal reduc. 45° HH 63 x 50
5000/55528 IPS Desague Ramal reduc. 45° HH 110 x 50
5000/55529 IPS Desague Ramal reduc. 45° HH 110 x 63



5000/55552 IPS Desague Ramal invertido 45° 50



5000/55596 IPS Desague Ramal doble 90° 110



5000/55598 IPS Desague Ramal doble 90° c/ventilacion



5000/55597 IPS Desague Ramal doble 90° c/doble ventilacion



5000/55599 IPS Desague Ramal simple 90° c/ventilacion



5000/55910 IPS Desague Rejilla acero c/marco 10 x 10

5000/55912 IPS Desague Rejilla acero c/marco 12 x 12



5000/55911 IPS Desague Tapa acero c/marco 10 x 10

5000/55913 IPS Desague Tapa acero c/marco 12 x 12



ACCESORIOS AWADUCT/POLIMEX

92100 Codo poliangular 40 HH 90 awaduct

92105 Codo poliangular 50 HH 90 awaduct

92112 Codo poliangular 63 HH 90 awaduct



92256 Buje reduccion 40 x 32 awaduct

92101 Buje reduccion 50 x 40 awaduct

92080 Buje reduccion 63 x 40 awaduct

92081 Buje reduccion 63 x 50 awaduct

92082 Buje reduccion 110 x 40 awaduct

92083 Buje reduccion 110 x 50 awaduct

92084 Buje reduccion 110 x 63 awaduct



- 94006 Porta reja 8 x 8 acero POLIMEX
- 94002 Porta reja 12 x 12 acero POLIMEX
- 94003 Porta reja 15 x 15 acero POLIMEX



- 94007 Porta tapa 8 x 8 acero POLIMEX
- 94004 Porta tapa 12 x 12 acero POLIMEX
- 94005 Porta tapa 15 x 15 acero POLIMEX



- 94098 Sopapa a codo awaduct



- 94128 Sopapa recta awaduct



- 94135 Valvula antiplaga awaduct



- 942046 Camara desengrasadora c/sif y filtro awaduct



ACCESORIOS PVC SOLDABLE

- 1050/300 Manguito soldable RM 40 x 1 1/4
- 1050/301 Manguito soldable RM 40 x 1 1/2
- 1050/302 Manguito soldable RM 50 x 1 1/2
- 1050/303 Manguito soldable RM 50 x 2
- 1050/304 Manguito soldable RM 63 x 2
- 1050/305 Manguito soldable RM 63 x 2 1/2



- 1050/306 Codo soldable 45° 40
- 1050/307 Codo soldable 45° 50



1050/308 Codo soldable 90° 40
1050/309 Codo soldable 90° 50



1050/310 Curva soldable 90° 40
1050/311 Curva soldable 90° 50



1050/312 Tee soldable 40
1050/313 Tee soldable 50



1050/314 Cupla soldable 40
1050/315 Cupla soldable 50



1050/316 Union doble soldable 40
1050/317 Union doble soldable 50



1050/318 Manguito soldable RH 40 x 1 1/4
1050/319 Manguito soldable RH 50 x 1 1/2



ACCESORIOS DE ZINGUERIA

1060/01 Caño flexible aluminio 3" 0,50 a 1 mt
1060/02 Caño flexible aluminio 4" 0,50 a 1 mt
1060/03 Caño flexible aluminio 3" 1 a 2 mt
1060/04 Caño flexible aluminio 4" 1 a 2 mt



ABRAZADERAS

7201	ABRAZADERA AG9 8-12
7203	ABRAZADERA AG9 10-16
7205	ABRAZADERA AG9 12-20
7207	ABRAZADERA AG9 16-25
7209	ABRAZADERA AG9 20-32
7211	ABRAZADERA AG9 25-40
7213	ABRAZADERA AG9 32-50
7215	ABRAZADERA AG9 40-60



ACOPLE RAPIDO

1070/01	Acople rapido 1/2 duke
1070/02	Acople rapido 3/4 duke
1070/03	Acople rapido 1 duke
1070/04	Acople rapido 1 1/4 duke
1070/05	Acople rapido 1 1/2 duke
1070/06	Acople rapido 2 duke
1070/09	Acople rapido 1/2 largo duke
1070/10	Acople rapido 3/4 largo duke
1070/11	Acople rapido 1/2 a codo duke
1070/12	Acople rapido 3/4 a codo duke
1070/13	Acople rapido tee 1/2 duke
1070/14	Acople rapido tee 3/4 duke



ACOPLES RAPIDO ENCHUFANDO

1070/07	Acople rapido enchufando prof. 1/2
1070/08	Acople rapido enchufando prof. 3/4



ALARGUES PARA CANILLAS Y MESADA

1080/01	Aalargue canilla cromo 1/2 x 1/2
1080/02	Aalargue canilla cromo 1/2 x 3/4
1080/03	Aalargue canilla cromo 1/2 x 1
1080/04	Aalargue canilla cromo 1/2 x 1 1/4
1080/05	Aalargue canilla cromo 1/2 x 1 1/2
1080/06	Aalargue canilla cromo 1/2 x 2
1080/06A	Alargue canilla cromo 1/2 x 3
1080/06B	Alargue canilla cromo 1/2 x 4
1080/07	Aalargue canilla cromo 3/4 x 1
1080/07A	Alargue canilla cromo 3/4 x 3/4
1090/01	Alargue o prolongador de griferia para mesada



ARANDELAS AJUSTE PARA TAPA IDEAL

1100/01	Arandela ajuste blanca para tapa ideal
1100/02	Arandela ajuste cromada para tapa ideal
1100/03	Arandela ajuste cromada para tapa yunque
1100/03A	Arandela ajuste blanca para tapa yunque
1100/03B	Arandela ajuste tapa LA PALANQUITA



ARANDELAS DE FIBRA

1100/04	Arandela fibra 3/8
1100/05	Arandela fibra 1/2 fina
1100/06	Arandela fibra 1/2 ancha
1100/07	Arandela fibra 3/4 fina
1100/08	Arandela fibra 3/4 ancha
1100/09	Arandela fibra 1 fina
1100/10	Arandela fibra 1 ancha
1100/10A	ARANDELA FIBRA PARA CABEZAL



ARANDELAS PVC PARA BRIDA

1100/11	Arandela para brida de tanque 1/2
1100/12	Arandela para brida de tanque 3/4
1100/13	Arandela para brida de tanque 1
1100/14	Arandela para brida de tanque 1 1/4
1100/15	Arandela para brida de tanque 1 1/2
1100/16	Arandela para brida de tanque 2



ARANDELAS DE PVC

1100/17	Arandela PVC 1/2 x 100 unidades
1100/18	Arandela PVC 3/4 x 100 unidades
1100/17A	Arandela PVC 1/2 x 100 unidades CAF
1100/18A	Arandela PVC 3/4 x 100 unidades CAF
1100/29A	Arandelas conicas para flexible 1/2
1100/29B	ARANDELA CONICA ROJA 1/2
1100/29C	ARANDELA CONICA ROJA 3/4
1100/19	Arandela PVC plana agujero 1/2 para griferia
1100/20	Arandela PVC plana agujero 3/4 para griferia
1100/21	Arandela PVC conica agujero 1/2 para griferia
1100/22	Arandela PVC conica agujero 3/4 para griferia



ARANDELAS PLASTICAS

1100/23	Arandela plastica 3/8
1100/24	Arandela plastica 1/2
1100/25	Arandela plastica 3/4
1100/26	Arandela plastica 1
1100/27	Arandela plastica para cabezal 1/2
1100/28	Arandela plastica para cabezal 3/4
1100/29	Arandela plastica conica para flexible 1/2

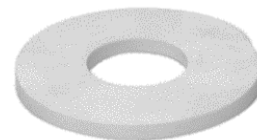

ARANDELAS DE GOMA

1100/30	Arandela de goma para union manga 1/2
1100/31	Arandela de goma para union manga 3/4
1100/33	Arandela de goma para garrafa de 3 KG
1100/34	Arandela de goma sopapa de 1 1/2 tipo o´ring
1100/35	Arandela de goma plana para sopapa 1 1/2
1100/36	Arandela de goma plana para sopapa 2
1100/37	Arandela de goma plana flexible 1/2 ala ancha
1100/38	Arandela de goma plana flexible 3/4 ala ancha
1100/39	Arandela de goma plana para flexioble 1



ARO BASE INODORO

1110/01	Aro base de PVC para inodoro
1110/02	Aro base de PVC regulable para inodoro



ARO BASE DESPLAZADO

1110/03	Aro desplaza inodoro 5 cm
1110/04	Aro desplaza inodoro 15 cm



ARO TRANSICION GOMA

1110/10 Aro junta trans. Caño fundicion a plastico



ARTICULOS PLASTICOS

1110/05 Codo de PVC para mezclador plastico

1110/06 Mezclador plastico con dos codos



1110/07 Union manguera riego 1/2 plastica

1110/08 Union manguera riego 3/4 plastica

1110/09 Union manguera riego 3/4 x 1/2 plastica



AUTOMATICO PARA TANQUE

1130/01 Automatico para tanque a tanza (Economico)



1130/02 Automatico para tanque 15 amperes (Super)



BACHAS ACERO INOXIDABLE (MI PILETA)

103EC Bacha simple acero (52 x 32 x 15)



104EC Bacha doble acero (57 x 37 x 15)



BARRALES DE SEGURIDAD

1140/21 BARRAL SEGURIDAD BLANCO 25 CM

1140/22 BARRAL SEGURIDAD BLANCO 35 CM

1140/23 BARRAL SEGURIDAD BLANCO 45 CM

1140/24 BARRAL SEGURIDAD BLANCO 60 CM

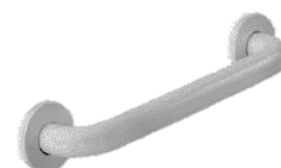

BALANCINES Y BRAZOS PARA MOCHILA

1140/01	Brazo regulable para mochila	
1140/02	Brazo regulable para entrada de agua	
1140/03	Balancin para boton lateral	
1140/04	Balancin para boton superior	
1140/05	Balancin para boton chico CAPEA-DELTA	
1140/06	Brazo balancin de bronce CAPEA-DELTA	
1140/07	Brazo de bronce corto punta plastica	
1140/08	Brazo de bronce largo punta plastica	
1140/09	Brazo cabeza bronce corto	
1140/10	Brazo cabeza bronce largo	
1140/11	Brazo con buje para boton redondo FERRUM	

BALANCINES Y BRAZOS DEPOSITO PARED

1140/12	Brazo corto para deposito FRANKLIN	
1140/13	Brazo largo para deposito FRANKLIN	
1140/14	Balancin de bronce deposito cadena IDEAL	
1140/15	Balancin de bronce completo IDEAL	
1140/16	Balancin de bronce solo cadena FRANKLIN	
1140/17	Balancin de bronce completo FRANKLIN	
1140/18	Brazo balancin plastico completo IDEAL	
1140/19	Brazo actual FLUMAX	
1140/20	Brazo con forma IDEAL	

BOTONES Y REPUESTOS PARA DEPOSITO PARED

1150/01 Boton de bronce corto cromado

1150/02 Boton de bronce largo cromado

1150/03 Gatillo de bronce boton flumax

1150/04 Gatillo de bronce boton franklin

1150/01A Pulsador de bronce corto para boton

1150/01B Pulsador de bronce largo para boton



BOTONES PARA DEPOSITO PLASTICO

1150/05 Boton de plastico blanco para deposito

1150/06 Boton de plastico cromo para deposito



BOTONES PARA MOCHILA

1150/07 Boton lateral para mochila CAPEA cromo

1150/08 Boton lateral para mochila CAPEA blanco

1150/09 Boton superior para mochila CAPEA cromo

1150/10 Boton superior para mochila CAPEA blanco

1150/11 Boton blanco chico mochila CAPEA-DELTA

1150/12 Boton cromo chico mochila CAPEA-DELTA

1150/13 Boton redondo blanco completo FERRUM

1150/13A Boton tipo FERRUN rectangular

1150/14 Boton para mochila MOTTA

1150/15 Boton neumatico para mochila MOTTA (420413)

1150/16 Boton cromo mochila ROCA original/AQUA STOP (420733)

1150/17 Boton para mochila ROCA NACIONAL (420233)

1150/18 Boton AQUA DUO (420523)



BOYAS TELGOPOR PARA DEPOSITO Y TANQUES

1160/01	Boya telgopor 2 roscas extrachata
1160/01A	Boya telgopor 2 roscas extrachata ENNA
1160/02	Boya telgopor comun 1
1160/03	Boya telgopor presion 1/2
1160/04	Boya telgopor presion 3/4
1160/05	Boya telgopor presion 1
1160/06	Boya telgopor presion 1 1/4
1160/07	Boya telgopor presion 1 1/2
1160/08	Boya telgopor presion 2



BOYAS PARA DEPOSITOS ,TANQUES Y MOCHILAS DE PLASTICO

1160/09	Boya triangular para mochila
1160/10	Boya para brazo articulado de mochila
1160/11	Boya grande para brazo articulado de mochila
1160/12	Boya chata o comun inyectada 2 roscas
1160/13	Boya extrachata inyectada 2 roscas
1160/14	Boya plastica para tanque 1/2
1160/15	Boya plastica para tanque 3/4
1160/16	Boya plastica para tanque 1



BUJES Y GOMAS PARA TRANSFERENCIAS

1180/01	Buje goma y bronce transferencia PIAZZA
1180/02	Buje goma transferencia bidet antiguo
1180/03	Buje goma transferencia bidet moderno
1180/04	Buje goma transferencia duchador PIAZZA
1180/05	Buje goma transferencia lluvia PIAZZA moderno



CALEFONES ELECTRICOS



1180/06
Calefon plastico con
resistencia de aluminio



1180/07
Calefon chapa con
resistencia de aluminio



1180/08
Calefon acero inoxidable
resistencia aluminio



1180/09
Resistencia de aluminio



1180/10
Resistencia de bronce

CAMARA DE INSPECCION, AROS Y ANTIRRETORNO

1180/11
Camara de
inspeccion



1180/13
Valvula antirretorno



1180/12
Aros de
suplemento



1180/14
Adaptador con oring
para valvula
antirretorno



CAMARAS SILENCIOSAS PARA DEPOSITO

1190/01
Camara silenciosa



1190/03
Camara silenciosa plastica
completa hembra



1190/04
Camara silenciosa
plastica completa macho

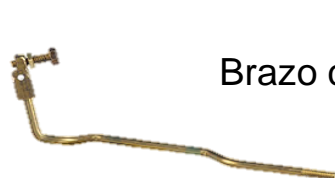

1190/05
Brazo completo para camara
silenciosa



1190/06
Piston de bronce para
camara silenciosa

CAJA VEREDA DOMICILIARIA

1190/02 Caja de vereda domiciliaria



CANILLAS DE BRONCE

1210/01 Canilla 1/2 manga bronce

1210/02 Canilla 3/4 manga bronce

1210/03 Canilla 1/2 manga cromo

1210/04 Canilla 3/4 manga cromo



CANILLAS ESFERICAS METALICAS

1210/05 Canilla esferica 1/2

1210/06 Canilla esferica 3/4

1210/15 Canilla esferica 1 metal

1210/18 Canilla esf. 1/2 economica metal

1210/19 Canilla esf. 3/4 economica metal



CANILLAS PLASTICAS

1210/07 Canilla plastica 1/2 DUKE

1210/08 Canilla plastica 3/4 DUKE

1210/08A Canilla plastica nueva volante cruz 1/2

1210/08B Canilla plastica nueva volante cruz 3/4

1210/09A Canilla plastica doble para lavarropa

1210/11A Canilla plastica pico levantado blanca

1210/11B Canilla plastica pico levantado cromo

1210/13A Canilla plastica 1 agua pared blanca

1210/13B Canilla plastica pared cromada 1 agua

1210/14A Canilla plastica 1 agua mesada blanca

1210/14B Canilla plastica mesada cromada 1 agua



CANILLAS VARIAS

- | | |
|---------|---|
| 1210/10 | Canilla doble para lavarropa metalica |
| 1210/11 | Canilla para lavatorio pico levantado bronce |
| 1210/13 | Canilla pico movil pared 1 agua bronce cromado |
| 1210/14 | Canilla pico movil mesada 1 agua bronce cromado |
| 1210/16 | Canilla simple para lavarropa |
| 1210/17 | Canilla doble lavarropa esferica |



CAÑO COBRE

- | | |
|---------|-------------------------|
| 1220/01 | Caño cobre 3/8 x metro |
| 1220/02 | Caño cobre 5/16 x metro |



CAÑO ALUMINIO

- | | |
|---------|----------------------------|
| 1220/03 | Caño aluminio 3/8 x metro |
| 1220/04 | Caño aluminio 5/16 x metro |



CAÑOS PLASTICOS PARA BAJADA DEPOSITO COLGAR

- | | |
|---------|---------------------------------------|
| 1220/05 | Caño plastico bajada deposito embutir |
| 1220/06 | Caño plastico bajada deposito cadena |



CAÑOS TERMOFUSION VERDE

1220/07	Caño fusion 20 mm x 4 metros 2,8 MM
1220/08	Caño fusion 25 mm x 4 metros 3,4 MM
1220/09	Caño fusion 32 mm x 4 metros 4,2 MM
1220/09A	Caño fusion 40 mm x 4 metros 5,2 MM
1220/09B	Caño fusion 50 mm x 4 metros 6,8 MM
1220/09C	Caño fusion 63 mm x 4 metros 8,2 MM



CAÑOS PVC

1220/19	Caño 40 x 4 mts BLANCO
1220/20	Caño 50 x 4 mts BLANCO
1220/21	Caño 60 x 4 mts BLANCO
1220/22	Caño 100 x 4 mts BLANCO
1220/25	Caño 63 x 4 mts BLANCO
1220/26A	Caño 110 x 4 mts BLANCO
1220/28	Caño 160 x 4 mts BLANCO



1220/19A	CAÑO 40 GRIS
1220/20A	CAÑO 50 GRIS
1220/21A	CAÑO 60 GRIS
1220/22A	CAÑO 100 GRIS
1220/26B	CAÑO 110 GRIS



1220/26 Caño 110 x 4 mts Reforzado Linea Roja

1220/27 Caño 110 x 4 mts TIPO DURATOP CON ORING



CAÑOS DE POLIPROPILENO

1220/10	Caño polipropileno 1/2 Bicapa X 4MTS
1220/11	Caño polipropileno 3/4 Bicapa X 4MTS
1220/12	Caño polipropileno 1 Bicapa X 4MTS
1220/13	Caño polipropileno 1/2 Tricapa X 4 MTS
1220/14	Caño polipropileno 3/4 Tricapa X 4 MTS
1220/15	Caño polipropileno 1 Tricapa X 4 MTS
1220/10A	Caño polipropileno 1 1/4 Bicapa X 4MTS
1220/11A	Caño polipropileno 1 1/2 Bicapa X 4MTS
1220/12A	Caño polipropileno 2 Bicapa X 4MTS



CAÑOS POLIETILENO X 100 MTS

1220/16	Caño polietileno 1/2 (rollo) K4
1220/17	Caño polietileno 3/4 (rollo) K4
1220/18	Caño polietileno 1 (rollo) K4
1220/18a	Caño polietileno 1 1/4 (rollo) K4
1220/18b	Caño polietileno 1 1/2(rollo) K4
1220/18c	Caño polietileno 2 (rollo) K4



CARTUCHOS PARA MONOCOMANDO

1230/01	Cartucho monocomando de cocina de 40
1230/03	Cartucho monocomando de cocina de 35
1230/02	Cartucho monoc. cocina de 40 transferencia
1230/04	Cartucho monoc. cocina de 35 transferencia



CHAVETAS VARIAS

1240/01	Chaveta para cabezal no ascendente alambre
1240/02	Chaveta para cabezal no ascendente seeger
1240/03	Chaveta para terocupla tipo seeger
1240/04	Chaveta con rosca
1240/05	Chaveta para flotante alata presion



CODOS EXCENTRICOS PARA GRIFERIA

1250/02	CODO EXCENTRICO CORTO X UNIDAD
1250/03	CODO EXCENTRICO LARGO X UNIDAD



CONEXIÓN COCINA COMPLETA

1250/01	Conexión cocina aluminio rigida completa
---------	--



CONEXIONES FUELLE GOMA

- | | |
|---------|----------------------------|
| 1260/01 | Conexión fuelle goma corto |
| 1260/02 | Conexión fuelle goma largo |



CONEXIONES FUELLE PVC

- | | |
|---------|---|
| 1260/05 | Conexión fuelle PVC corto |
| 1260/06 | Conexión fuelle PVC largo |
| 1260/08 | Conexión fuelle para mochila |
| 1260/18 | Conexión fuelle PVC DECA 1.1/2 |
| 1260/19 | Conexión fuelle PVC DECA 2 |
| 1260/21 | Conexión fuelle PVC mochila extralargo |
| 1260/23 | Conexión fuelle extensible mochila c/ 2 tuercas |
| 1260/46 | Conexión exten. largo mochila 2 tuercas |
| 1260/24 | Conexión PVC tubular Magnano |
| 1260/26 | Conexión PVC Olmos |



CONEXIONES FUELLE PVC

- | | |
|---------|---|
| 1260/27 | Conexión PVC Trafal comun |
| 1260/28 | Conexión PVC 1 1/2 para inodoro importado |
| 1260/29 | Conexión PVC para deposito de colgar |



CONO PARA DEPOSITO GASTADO

1260/09 Cono para deposito gastado chico

1260/10 Cono para deposito gastado grande



CORTACHORROS PARA PICOS DE GRIFERIA

1260/42 Cortachorro plastico cromo H chico

1260/43 Cortachorro plastico cromo H grande

1260/44 Cortachorro plastico cromo M



CUBREAGUJERO CROMADO

1260/45 Cubreagujero plastico cromo para mesada



CUPLAS Y TUBOS PARA SOLDAR

1270/01 Cupla de 1/2 para soldar plomo

1270/02 Cupla de 3/4 para soldar plomo

1270/03 Tubo macho de 1/2 para soldar plomo

1270/04 Tubo macho de 3/4 para soldar plomo



DISCOS BAROVO

1800/01 Disco de corte 4 1/2 x 1,6 mm



DEPOSITO PLASTICO EMBUTIR COMPLETO

1270/06 Deposito embutir chato universal plastico



DEPOSITOS DE COLGAR Y MOCHILAS PLASTICAS

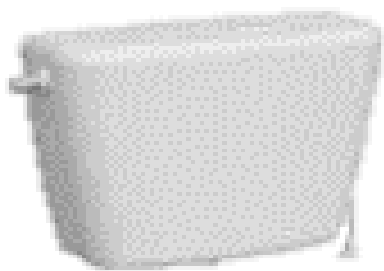

1270/09
DEPOSITO DE COLGAR
DEALER



1270/10
DEPOSITO DE MOCHILA
AQUA DUO DEALER



1270/11
DEPOSITO DE
MOCHILA DEALER



1270/12
DEPOSITO DE
MOCHILA EGOPLAST



1270/13
DEPOSITO DE MOCHILA
SIMIL LOZA



1270/14
DEPOSITO DE COLGAR
EGOPLAST

ESQUINEROS ORGANIZADORES PARA BAÑOS

1290/20
Esquinero chico
2 estantes

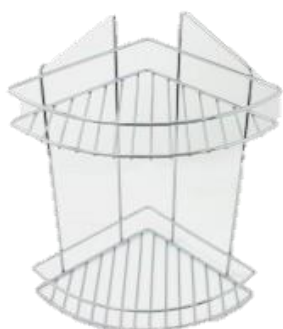

1290/21
Esquinero chico
3 estantes



1290/22
Esquinero grande
2 estantes

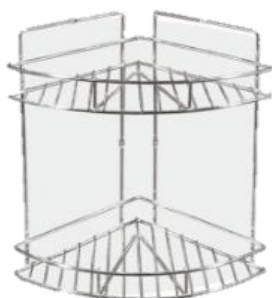

1290/23
Esquinero negro
chico 2 estantes

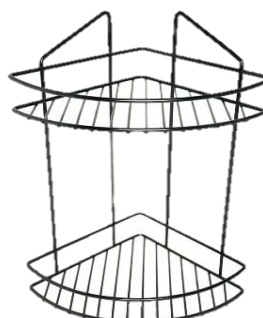

DUCHADORES Y ACCESORIOS



1280/01
Duchador cromado
completo con soporte



1280/02
Duchador solo cromo
anticalcareo



1280/03
Duchador plastico de
mano portatil



1280/04
Tee derivacion cromada
para duchador



1280/05
Soporte plastico cromado para
duchador



1280/07
Duchador bidet c/gatillo



1280/08
Soporte plastico movil para



1280/09
Tee de derivacion bronce



1280/10
Soporte duchador articulado

ESTAÑO EN BARRA

1290/01 Estaño del 33% x kg

1290/02 Estaño del 50% x kg



ESTUFAS ELECTRICAS

1290/06 Estufa electrica chapa



ENTRERROSCAS PARA DEPOSITO

1290/03 Entrerosca de plastico 1/2 x 1/2

1290/04 Entrerosca de bronce 1/2 x 3/8

1290/05 Entrerosca de bronce 1/2 x 1/2

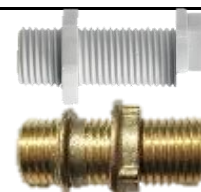

EYECTOR PARA BOMBEADOR

1660/17 Eyector para bombeador



FLEXIBLES PARA DUCHADOR

1300/01 Flexible para duchador de 150 cm

1300/02 Flexible para duchador de 180 cm

1300/03 Flexible para duchador de 200 cm



FLEXIBLES PARA MONOCOMANDO

1300/04 Flexible mallado para monocomando

1300/04A Flexible mallado monocomando FV



FLEXIBLES MALLADOS

1300/05 Flexible mallado 1/2 x 20 cm

1300/06 Flexible mallado 1/2 x 25 cm

1300/07 Flexible mallado 1/2 x 30 cm

1300/08 Flexible mallado 1/2 x 35 cm

1300/09 Flexible mallado 1/2 x 40 cm

1300/10 Flexible mallado 1/2 x 50 cm

1300/11 Flexible mallado 3/4 x 25 cm

1300/12 Flexible mallado 3/4 x 30 cm

1300/12B Flexible mallado 3/4 x 35 cm

1300/13 Flexible mallado 3/4 x 40 cm

1300/14 Flexible mallado 3/4 x 50 cm



FLEXIBLE MALLADO PARA BOMBA

1300/60 Flexible malladop/bomba 1 x 50 cm



FLEXIBLES DE COBRE

1300/15 Flexible de cobre 1/2 x 20

1300/16 Flexible de cobre 1/2 x 25

1300/17 Flexible de cobre 1/2 x 30

1300/18 Flexible de cobre 1/2 x 35

1300/19 Flexible de cobre 1/2 x 40

1300/20 Flexible de cobre 1/2 x 50

1300/23 Flexibles de cobre 3/4 x 20

1300/24 Flexibles de cobre 3/4 x 25

1300/25 Flexibles de cobre 3/4 x 30

1300/26 Flexibles de cobre 3/4 x 35

1300/27 Flexibles de cobre 3/4 x 40

1300/28 Flexibles de cobre 3/4 x 50



FLEXIBLES PARA BIDET

1300/31 Flexible para bidet completo 3/8

1300/32 Flexible para bidet completo 1/2



FLEXIBLES PLASTICOS REGULARES (GRIS)

1300/33 Flexible plastico 1/2 x 30

1300/34 Flexible plastico 1/2 x 40

1300/35 Flexible plastico 1/2 x 50



FLEXIBLES MALLADOS PARA GAS

1300/36 Flexible de gas x 30 cm

1300/37 Flexible de gas x 40 cm

1300/38 Flexible de gas x 50 cm

1300/39 Flexible de gas x 60 cm

1300/40 Flexible de gas x 70 cm

1300/41 Flexible de gas x 80 cm

1300/42 Flexible de gas x 1,00 cm

1300/43 Flexible de gas x 1,20 cm

1300/44 Flexible de gas x 1,50 cm



FLEXIBLES GAS APROBADOS (ACERO INOX)

- 1300/45 Flexible gas aprobado extensible 20 a 45 cm
- 1300/46 Flexible gas aprobado extensible 45 a 90 cm



FLEXIBLES ACERO INOX. MACHO GIRATORIO

- 1300/61 Flexible acero inox. 1/2 x 30 Macho giratorio
- 1300/62 Flexible acero inox. 1/2 x 35 Macho giratorio
- 1300/63 Flexible acero inox. 1/2 x 40 Macho giratorio
- 1300/64 Flexible acero inox. 1/2 x 50 Macho giratorio
- 1300/65 Flexible acero inox. 3/4 x 30 Macho giratorio
- 1300/66 Flexible acero inox. 3/4 x 35 Macho giratorio
- 1300/67 Flexible acero inox. 3/4 x 40 Macho giratorio
- 1300/68 Flexible acero inox. 3/4x 500 Macho giratorio



FLEXIBLES PLASTICOS CORRUGADOS

- 1300/48 Flexible corrugado rosca 1 1/4
- 1300/49 Flexible corrugado rosca 1 1/2
- 1300/50 Flexible corrugado exten.(40/50) cromado
- 1300/52 Flexible corrugado extensible (40/50) 55 cm
- 1300/53 Flexible corrugado extensible (40/50) 1 metro



FLOTANTES DE BRONCE PARA TANQUE

- 1310/01 Flotante alta presion 1/2
- 1310/02 Flotante alta presion 3/4
- 1310/03 Flotante alta presion 1
- 1310/04 Flotante alta presion 1 1/4
- 1310/05 Flotante alta presion 1 1/2
- 1310/06 Flotante alta presion 2
- 1310/07 Flotante semi presion 1/2 cola macho
- 1310/08 Flotante semi presion 1/2 cola hembra
- 1310/09 Flotante semi presion 3/4 cola macho
- 1310/10 Flotante semi presion 3/4 coal hembra



FLOTANTES PLASTICOS PARA TANQUE

- 1310/01A Flotante plastico p/tanque 1/2
- 1310/02A Flotante plastico p/tanque 3/4
- 1310/03A Flotante plastico 1/2 y 3/4 dealer



FILTROS ACERO PARA VALVULA RETENCION

- 1310/11 Filtro 3/4 acero valvula retencion
- 1310/12 Filtro 1 acero valvula retencion



FILTROS DE ACERO PARA BACHAS

- 1310/20 Filtro acero p/bacha cocina



FILTROS Y REPUESTOS PARA TANQUES

- 1310/30 Filtro completo para tanque (F95)
- 1310/31 Cartucho repuesto para filtro (F95)
- 1310/32 Cartucho repuesto filtro ROTOPLAS



GOMAS VARIAS

- 1320/01 Goma siliconada para valvula 1/2
- 1320/02 Goma sintetica para valvula 3/8
- 1320/03 Goma sintetica para valvula 1/2
- 1320/04 Goma sintetica para valvula 1/2 PIAZZA
- 1320/05 Goma sintetica para valvula 3/4
- 1320/06 Goma sintetica para valvula 1
- 1320/07 Goma para flotante de tanque 1/2 y 3/4
- 1320/08 Goma para flotante de tanque 1
- 1320/09 Goma para camara silenciosa
- 1320/10 Goma para piston Franklin x 100
- 1320/11 Goma puntera garrafa 10 KG



1320/12 Goma repuesto obturador IDEAL



1320/13 Goma tipo oring para corrugado mochila

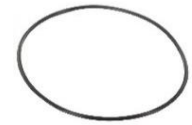

GRAMPAS VARIAS

1330/01 Grampa para lavatorio corta

1330/02 Grampa para lavatorio larga

1330/03 Grampa para lavatorio doble nervio

1330/03A Grampa tipo L con taco y tornillo x 2 unidades

1330/03B Grampa para bacha de acero



GRAMPA PARA TERMOTANQUE

1330/04 Grampa para termotanque reforzada



GRAMPAS MEDIA OMEGA

1330/05 Grampa media omega 1/4 para gas

1330/06 Grampa media omega 3/8 para gas

1330/07 Grampa media omega 1/2

1330/08 Grampa media omega 3/4

1330/09 Grampa media omega 1



GRAMPAS OMEGA

1330/10 Grampa omega 1/2

1330/11 Grampa omega 3/4

1330/12 Grampa omega 1

1330/13 Grampa omega 1 1/4

1330/14 Grampa omega 1 1/2

1330/15 Grampa omega 2

1330/16 Grampa omega 63 praca caño PVC

1330/17 Grampa omega 2 1/2

1330/18 Grampa omega 3

1330/19 Grampa omega 4

1330/20 Grampa omega 110



GRIFO PARA TERMOTANQUE

1330/21 Grifo plastico para purgue termotanque 90°



INSERTOS DE BRONCE PARA VOLANTES

1340/01 Inserto bronce estria fina para volante

1340/02 Inserto bronce estria gruesa para volante

1340/03 Inserto bronce cuadrado para volante



INSERTOS DE PLASTICO PARA VOLANTES

1340/04 Inserto plastico estria fina para volante

1340/05 Inserto plastico estria gruesa para volante

1340/06 Inserto plastico cuadrado para volante

1340/07 Inserto plastico estria importada para volante



JUEGO METALICO DE ACCESORIOS PARA BAÑO



1350/01

Set de 5 piezas bronce cromado



1350/02

Set de 5 piezas bronce c/barral cromado

1350/01A Set de 6 piezas bronce cromado

1350/03 Aro para toalla de bronce cromado

1350/04 Barral toallero de bronce cromado

1350/05 Jabonera de bronce cromado

1350/06 Percha de bronce cromado

1350/07 Portarollo de bronce cromado

1350/08 Portavasos de bronce cromado

1350/05A Repuesto para jabonera DACCORD

1350/08A Repuesto para vaso portacepillo DACCORD



JUEGOS PLASTICOS DE ACCESORIOS PARA BAÑO

1350/09	Barral toallero estensible
1350/10	Barral toallero largo plastico
1350/11	Jabonera plastica
1350/13	Percha cuadrada plastica x 15
1350/14	Perchero simple plastico
1350/15	Portacepillo y vaso plastico
1350/16	Portarollo para baño plastico
1350/17	Portarollo para cocina plastico
1350/18	Toallero chico
1350/19	Set 7 piezas para baño blanco ARSPLASTIC



KIT DE FIJACION PARA MONOCOMANDO

1350/35	Kit de fijacion para monocomando 1 agujero
1350/36	Kit de fijacion para monocomando 2 agujero



LLAVES DE PASO ESFERICA METALICAS CAFU

1360/01	Llave paso esferica 1/2
1360/02	Llave paso esferica 3/4
1360/03	Llave paso esferica 1



LLAVES PASO ESFERICAS METALICAS REFORZADAS

1360/43	Llave paso esferica 1/2 reforzada
1360/44	Llave paso esferica 3/4 reforzada
1360/45	Llave paso esferica 1 reforzada
1360/04	Llave paso esferica 1 1/4 reforzada
1360/05	Llave paso esferica 1 1/2 reforzada
1360/06	Llave paso esferica 2 reforzada



LLAVES DE PASO ESFERICAS PLASTICAS DUKE

1360/07	Llave paso DUKE 1/2
1360/08	Llave paso DUKE 3/4
1360/09	Llave paso DUKE 1
1360/10	Llave paso DUKE 1 1/4
1360/11	Llave paso DUKE 1 1/2
1360/12	Llave paso DUKE 2
1360/52	Llave paso p/pegar 40 DUKE
1360/53	Llave paso p/pegar 50 DUKE
1360/54	Llave paso p/pegar 63 DUKE



LLAVES DE PASO PLASTICA KRONA

1360/46	Llave paso plastica Krona 1/2
1360/47	Llave paso plastica Krona 3/4
1360/48	Llave paso plastica Krona 1
1360/49	Llave paso plastica Krona 1 1/4
1360/50	Llave paso plastica Krona 1 1/2
1360/51	Llave paso plastica Krona 2



LLAVES DE PASO PLASTICAS ECONOMICAS

1360/13	Llave paso plastica 1/2
1360/14	Llave paso plastica 3/4
1360/15	Llave paso plastica 1
1360/16	Llave paso plastica 1 1/4
1360/17	Llave paso plastica 1 1/2
1360/18	Llave paso plastica 2



LLAVES DE PASO BRONCE CON VALVULITA

1360/19	Llave de paso bronce 1/2
1360/20	Llave de paso bronce 3/4
1360/21	Llave de paso bronce 1/2 con campana
1360/22	Llave de paso bronce 3/4 con campana



LLAVES DE PASO GAS APROBADAS

1360/23	Llave paso gas 1/2
1360/24	Llave paso gas 3/4
1360/25	Llave paso gas 1
1360/26	Llave paso gas 1 1/4
1360/27	Llave paso gas 1 1/2
1360/28	Llave paso gas 2
1360/29	Llave paso gas 1/2 con campana
1360/30	Llave paso gas 3/4 con campana
1360/31	Llave paso gas candado 3/4
1360/32	Llave paso gas candado 1



LLAVES PASO GAS ESFERICA

1360/60	Llave paso esferica 4 Bar 3/4 gas
---------	-----------------------------------



LLAVES DE PASO TERMOFUSION

- 1360/33 Llave de paso fusion 20 mm con campana
- 1360/34 Llave de paso fusion 25 mm con campana
- 1360/35 Llave de paso fusion 32 mm con campana



- 1360/33A Llave de paso fusion 20 mm PLASTICA
- 1360/34A Llave de paso fusion 25 mm PLASTICA
- 1360/35A Llave de paso fusion 32 mm PLASTICA



LLAVINES PASO ESFERICO

- 1360/36 Minivalvula paso esferico MH 1/2
- 1360/36A Minivalvula paso esferico MM 1/2
- 1360/37 Minivalvula paso esferico HH 3/8
- 1360/38 Minivalvula paso esferico MH 3/8
- 1360/39 Minivalvula paso esferico MM 3/8
- 1360/40 Minivalvula paso esferico HH 1/4
- 1360/41 Minivalvula paso esferico MH 1/4
- 1360/42 Minivalvula paso esferico MM 1/4



LLAVES PASO ESCLUSAS

- 1360/70 Llave esclusa 1/2 bronce
- 1360/71 Llave esclusa 3/4 bronce
- 1360/72 Llave esclusa 1 bronce



MAQUINA DE TERMOFUSION

- 1370/01 Termofusora 800 watt con boquillas 20 a 32
- 1370/02 Termofusora 1200 watt con boquillas 20 a 63



MANGUERA DE RIEGO

- 1380/01 Manguera para riego 1/2 x 25 mts reforzada
- 1380/02 Manguera para riego 1/2 x 50 mts reforzada
- 1380/03 Manguera para riego 3/4 x 25 mts reforzada
- 1380/05 Manguera para riego 3/4 x 50 mts reforzada
- 1380/05A Manguera para riego 1 x 25 mts reforzada



MANGUERAS PARA CARGA DE LAVARROPA

1380/06	Manguera carga lavarropa x 120 cm
1380/07	Manguera carga lavarropa x 150 cm
1380/08	Manguera carga lavarropa x 180 cm
1380/09	Manguera carga lavarropa x 200 cm
1380/10	Manguera carga lavarropa x 250 cm
1380/11	Manguera carga lavarropa x 300 cm



MANGUERAS PARA DESCARGA DE LAVARROPA

1380/12	Manguera descarga lavarropa x 120 cm
1380/13	Manguera descarga lavarropa x 180 cm
1380/14	Manguera descarga lavarropa x 250 cm



MANGUERA APROBADA PARA GAS

1380/15	Manguera de goma para gas aprobada x 25 mts.
---------	--



MANIJAS DE BRONCE CROMADO PARA LLAVES DE GAS

1390/01	Manija cromada para gas cuadrada 8 mm
1390/02	Manija cromada para gas cuadrada 9 mm
1390/03	Manija cromada para gas cuadrada 10 mm
1390/04	Manija cromada para gas FV
1390/05	Manija cromada para gas QUEFE
1390/06	Manija cromada para gas BULLY



MESADAS DE ACERO CON BACHA (MI PILETA)

100102E	Mesada acero 1 mt con bacha simple
120103E	Mesada acero 1,20 mt con bacha simple
140103E	Mesada acero 1,40 mt con bacha simple
160103E	Mesada acero 1,60 mt con bacha simple



MONTURAS EPOXI

1390/50	Montura epoxi 1/2 x 1/2
1390/51	Montura epoxi 3/4 x 1/2
1390/52	Montura epoxi 3/4 x 3/4
1390/53	Montura epoxi 1 x 1/2
1390/54	Montura epoxi 1 x 3/4
1390/55	Montura epoxi 1 x 1
1390/56	Montura epoxi 1 1/4 x 1
1390/57	Montura epoxi 1 1/2 x 1 1/4
1390/58	Montura epoxi 2 x 1 1/2
1390/59	Montura epoxi 2 1/2 x 1 1/2
1390/60	Montura epoxi 3 x 1 1/2
1390/61	Montura epoxi 4 x 1 1/2



NICHOS CON PUERTA DE CHAPA APROBADA

1390/07	Nicho con puerta de chapa aprobada 40 x 50
1390/08	Nicho con puerta de chapa aprobada 40 x 60
1390/09	Nicho con puerta de chapa aprobada 45 x 65
1390/10	Nicho con puerta de chapa aprobada 27 x 65



NIPLES DE BRONCE

1400/01	Niple de bronce 1/2 x 5
1400/02	Niple de bronce 1/2 x 8
1400/03	Niple de bronce 1/2 x 10
1400/04	Niple de bronce 1/2 x 12
1400/05	Niple de bronce 1/2 x 15
1400/10	Niple de bronce 3/4 x 5
1400/11	Niple de bronce 3/4 x 8
1400/12	Niple de bronce 3/4 x 10
1400/13	Niple de bronce 3/4 x 12
1400/14	Niple de bronce 3/4 x 15
1400/19	Niple de bronce 1 x 5
1400/20	Niple de bronce 1 x 8
1400/21	Niple de bronce 1 x 10
1400/22	Niple de bronce 1 x 12
1400/23	Niple de bronce 1 x 15



NIPLES DE POLIPROPILENO BICAPA

1400/55	Niples de polipropileno 1/2 x 5
1400/56	Niples de polipropileno 1/2 x 8
1400/57	Niples de polipropileno 1/2 x 10
1400/58	Niples de polipropileno 1/2 x 12
1400/59	Niples de polipropileno 1/2 x 15
1400/60	Niples de polipropileno 1/2 x 20
1400/61	Niples de polipropileno 1/2 x 25
1400/62	Niples de polipropileno 1/2 x 30
1400/72	Niples de polipropileno 3/4 x 5
1400/73	Niples de polipropileno 3/4 x 8
1400/74	Niples de polipropileno 3/4 x 10
1400/75	Niples de polipropileno 3/4 x 12
1400/76	Niples de polipropileno 3/4 x 15
1400/77	Niples de polipropileno 3/4 x 20
1400/78	Niples de polipropileno 3/4 x 25
1400/79	Niples de polipropileno 3/4 x 30
1400/89	Niples de polipropileno 1 x 5
1400/90	Niples de polipropileno 1 x 8
1400/91	Niples de polipropileno 1 x 10
1400/92	Niples de polipropileno 1 x 12
1400/93	Niples de polipropileno 1 x 15
1400/94	Niples de polipropileno 1 x 20
1400/95	Niples de polipropileno 1 x 25
1400/96	Niples de polipropileno 1 x 30
1400/199	Niples de polipropileno 1 1/4 x 10
1400/200	Niples de polipropileno 1 1/4 x 12
1400/201	Niples de polipropileno 1 1/4 X 15
1400/202	Niples de polipropileno 1 1/4 X 20
1400/203	Niples de polipropileno 1 1/2 X 10
1400/204	Niples de polipropileno 1 1/2 X 12
1400/205	Niples de polipropileno 1 1/2 X 15
1400/206	Niples de polipropileno 1 1/2 X 20
1400/207	Niples de polipropileno 2 X 10
1400/208	Niples de polipropileno 2 X 12
1400/209	Niples de polipropileno 2 X 15
1400/210	Niples de polipropileno 2 X 20



NIPLES EPOXI

1400/106	Niple epoxy 1/2 x 5
1400/107	Niple epoxy 1/2 x 8
1400/108	Niple epoxy 1/2 x 10
1400/109	Niple epoxy 1/2 x 12
1400/110	Niple epoxy 1/2 x 15
1400/111	Niple epoxy 1/2 x 18
1400/112	Niple epoxy 1/2 x 20
1400/113	Niple epoxy 1/2 x 25
1400/114	Niple epoxy 1/2 x 30
1400/119	Niple epoxy 3/4 x 5
1400/120	Niple epoxy 3/4 x 8
1400/121	Niple epoxy 3/4 x 10
1400/122	Niple epoxy 3/4 x 12
1400/123	Niple epoxy 3/4 x 15
1400/124	Niple epoxy 3/4 x 18
1400/125	Niple epoxy 3/4 x 20
1400/126	Niple epoxy 3/4 x 25
1400/127	Niple epoxy 3/4 x 30
1400/132	Niple epoxy 1 x 5
1400/133	Niple epoxy 1 x 8
1400/134	Niple epoxy 1 x 10
1400/135	Niple epoxy 1 x 12
1400/136	Niple epoxy 1 x 15
1400/137	Niple epoxy 1 x 18
1400/138	Niple epoxy 1 x 20
1400/139	Niple epoxy 1 x 25
1400/140	Niple epoxy 1 x 30



NIPLES CONEXIÓN EPOXI COMPLETO CON TUERCA Y CUPLA

1400/193	Niple conexión epoxy completo 1/2 x 8
1400/194	Niple conexión epoxy completo 1/2 x 15
1400/195	Niple conexión epoxy completo 3/4 x 8
1400/196	Niple conexión epoxy completo 3/4 x 15
1400/197	Niple conexión epoxy completo 1 x 8
1400/198	Niple conexión epoxy completo 1 x 15



NUECES PARA BRAZO DE LLUVIA

1410/01	Nuez comun para brazo de lluvia
1410/02	Nuez invertida para brazo de lluvia



NUECES PARA BRAZO DE LLUVIA

4803/30	Oring 007 serie 1,78mm
4803/31	Oring 008 serie 1,78mm
4803/32	Oring 009 serie 1,78mm
4803/33	Oring 010 serie 1,78mm
4803/34	Oring 011 serie 1,78mm
4803/35	Oring 012 serie 1,78mm
4803/36	Oring 013 serie 1,78mm
4803/37	Oring 014 serie 1,78mm
4803/38	Oring 016 serie 1,78mm
4803/39	Oring 018 serie 1,78mm
4803/40	Oring 021 serie 1,78mm
4803/41	Oring 023 serie 1,78mm
4803/42	Oring 026 serie 1,78mm
4803/43	Oring 107 serie 2,62mm
4803/44	Oring 108 serie 2,62mm
4803/45	Oring 109 serie 2,62mm
4803/46	Oring 110 serie 2,62mm
4803/47	Oring 111 serie 2,62mm
4803/48	Oring 112 serie 2,62mm
4803/49	Oring 113 serie 2,62mm
4803/50	Oring 114 serie 2,62mm
4803/51	Oring 115 serie 2,62mm
4803/52	Oring 118 serie 2,62mm
4803/53	Oring 120 serie 2,62mm
4803/54	Oring 124 serie 2,62mm
4803/55	Oring 202 serie 3,53mm
4803/56	Oring 206 serie 3,53mm
4803/57	Oring 208 serie 3,53mm
4803/58	Oring 210 serie 3,53mm
4803/59	Oring 212 serie 3,53mm
4803/60	Oring 214 serie 3,53mm
4803/61	Oring 216 serie 3,53mm
4803/62	Oring 218 serie 3,53mm
4803/63	Oring 221 serie 3,53mm

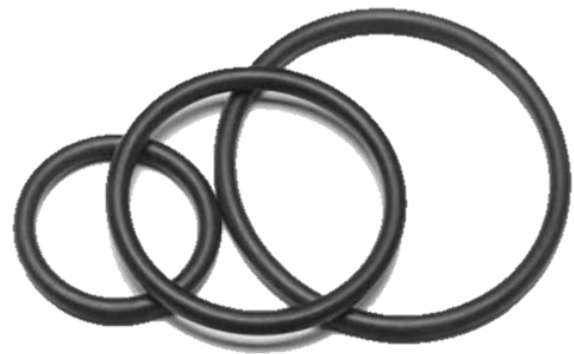

4803/75 ORING MONOCOMANDO DOBLE
LABIO 35 MM

4803/76 ORING MONOCOMANDO DOBLE
LABIO 40 MM

OBTURADOR PARA MOCHILA



**1420/01
OBTURADOR
CON ALAMBRE**



**1420/02
OBTURADOR
CON GANCHO**



**1420/03
OBTURADOR
CON TIRADOR
3/16**



**1420/04
OBTURADOR
CON TIRADOR
1/4**



**1420/05
OBTURADOR
VERONA**



**1420/20
OBTURADOR
MOCHILA
ECONOMICO**

OBTURADORES PARA DEPOSITO DE PARED



**1420/06
OBTURADOR
PARA DEP.
IDEAL
LEGITIMA**



**1420/07
OBTURADOR PARA
DEP. TABIQUE CON
ALAMBRE**



**1420/08
OBTURADOR
PARA DEP.
COMUN CON
ALAMBRE**



**1420/09
OBTURADOR
PARA DEPOSITO
DE COLGAR CON
ALAMBRE**



**1420/10
OBTURADOR PARA
DEPOSITO TIPO
IDEAL**



**1420/11
OBTURADOR
PARA DEP.
UNIVERSAL**



**1420/12
OBTURADOR
PARA DEP.
TABIQUE**



**1420/13
OBTURADOR
PARA DEP.
COMUN**



**1420/14
OBTURADOR
PARA DEP. TIPO**



**1420/15
OBTURADOR
PARA DEP. TIPO
PALANQUITA**



**1420/22
OBTURADOR
PARA DEP.
MALVAR CON**

OBTURADORES Y FLOTANTES EGEO



OBTURADOR
DEPOSITO
PARED



OBTURADOR DEPOSITO PARED
1420/24



FLOTANTE CON
BOYA 1/2
1420/25



FLOTANTE
CON BOYA
3/4
1420/26



OBTURADOR OBTUCONO
1420/27



OBTURADOR
UNIVERSAL
1420/28

PALITO PORTA ROLLO

1430/01

Palito portarollo plastico super



PICOS PARA GRIFERIA



1430/02
PICO J



1430/03
PICO S



1430/05
PICO FLEXIBLE COLOR



1430/04
PICO U



1430/06
PICO J GRUESO
55MM

PICOS/INYECTORES PARA COCINA



PICO/INYECTOR
STANDAR 7MM



PICO/INYECTOR VOLCAN
1430/21



PICO/INYECTOR ARISTON
1430/22



PICO/INYECTOR DOMEK
1430/23



PICO/INYECTOR ORBIS
CHATO



PICO/INYECTOR ARTHUR
ROSCA FINA
1430/25



PICO/INYECTOR
COVENTRY GRUESO
1430/26



PICO/INYECTOR
ESCORIAL LARGO
1430/27



PICO/INYECTOR PARA
CALENTADOR



PICO/INYECTOR
PARA FAROL
1430/29

PRENSAS Y CONITOS DE PVC x 100 unidades

- 1440/01 Conito PVC para ramal 3/8
- 1440/02 Conito PVC para ramal 1/2
- 1440/03 Prensa PVC para vástago FV
- 1440/04 Prensa PVC para vástago PEIRANO y PIAZZA



PILETAS PLASTICAS



**PILETA PARA LAVADERO
PLASTICA 15 LITROS
1440/05**



**PILETA PARA LAVATORIO
PLASTICA
1440/06**



**PILETA PARA LAVADERO
PLASTICA 24 LITROS
1440/08**



**PILETA LAVATORIO
CHICA COMPLETA
DEALER
1440/07**

PIEZOELECTRICO ESTRELLITA

- 1450/03 Piezo electrico estrellita sin masa (coc35)
- 1450/04 Piezo electrico Eskabe con masa (coc68)
- 1450/05 Piezo electrico Eurostar con masa (coc36)



PRODUCTOS/HERRAMIENTAS IPS



1460/10
TIJERA CORTA CAÑO



1460/11
HERRAMIENTA
CORTANTE
VANTEC



1460/34
CINTA IPSOLAR
10 MTS X 4 CM

1460/35
CINTA IPSOBAND
10 MTS X 5 CM



1460/38
CINTA ALUMINIO
VANTEC
48 MM X 30 MTS

PRODUCTOS QUIMICOS VARIOS



1460/01 - 1460/02 - 1460/03
LITARGIRIO



1460/04 - 1460/05 - 1460/06
GLICERINA



1460/07
DECAPANTE
LIQUIDO X 60CC



1460/14
ESTEARINA EN PANES X 220G



1460/15 - 1460/16
MASILLA DE 1/2 Y 1 KG



1460/18 - 1460/18A
CAÑAMO DE 20 Y 45 G



1460/36
HILO GRAFITADO



1460/37
PAÑO PARA SOLDAR



1460/46
TELA ESMERIL

PRODUCTOS QUIMICOS LAR

- 1460/12 Grasa grafitada x 21 cc LAR
- 1460/13 Grasa grafitada x 55 cc LAR
- 1460/22 Sella rosca para gas LAR 10 x 21 cc
- 1460/23 Sella rosca para gas LAR 10 x 55 cc



PRODUCTOS LOSUNG



- 1460/47 Sella rosca Losung HD 25 cc
- 1460/48 Sella rosca Losung HD 50 cc
- 1460/49 Sella rosca Losung HD 125 cc



- 1460/50 Sella Gas Losung 50 cc



- 1460/57
Sellador DUO Losung 25 cc



- 1460/51 Lubricante p/caño Losung 400 cc
- 1460/52 Lubricante p/caño Losung 240 cc



- 1460/53 Lubricante multiuso Losung 237 cc
- 1460/54 Lubricante multiuso Losung 400 cc



- 1460/55 Esmalte epoxi lata 250 cc
- 1460/56 Esmalte epoxi lata 500 cc



- 1460/58
Adhesivo PVC Prof.
Losung 250 cc
c/pincel



- 1460/59
Adhesivo PVC XT
Riego Losung 250 cc
c/pincel



- 1460/60
Sellador Anaerobico
gas 15 grs

PRODUCTOS QUIMICOS DUKE

- 1460/39 Adhesivo PVC x 50 cc Duke
- 1460/40 Adhesivo PVC x 100 cc Duke
- 1460/41 Adhesivo PVC x 250 cc Duke
- 1460/41A Adhesivo PVC x 500 cc Duke



PRODUCTOS QUIMICOS HIDRO 3 (SELLADORES)

- 1460/42 Sellador Hidro 3 para agua 25 cc
- 1460/43 Sellador Hidro 3 para agua 50 cc
- 1460/44 Sellador Hidro 3 para agua 125 cc



PUERTAS DE CHAPA APROBADAS PARA NICHOS DE GAS

- 1460/27 Puerta de chapa aprobada 40 x 50
- 1460/28 Puerta de chapa aprobada 40 x 60
- 1460/29 Puerta de chapa aprobada 45 x 65
- 1460/30 Puerta de chapa aprobada 27 x 65



PUERTAS DE CHAPA PARA NICHOS SIN APROBAR reforzada

- 1460/31 Puerta de gas 40 x 50
- 1460/32 Puerta de gas 40 x 60
- 1460/33 Puerta de gas 45 x 65



PUERTAS DE ACERO PARA LLAVE DE PASO

- 1460/80 Puerta llave paso acero 20 x 20
- 1460/81 Puerta llave paso acero 20 x 25



PUERTA DE HIERRO PARA LLAVE DE PASO

- 1460/90 Puerta llave paso hierro 20 x 20
- 1460/91 Puerta llave paso hierro 20 x 25



RAMALES PARA LAVATORIO

- 1470/01 Ramal para lavatorio 3/8
- 1470/02 Ramal para lavatorio 3/8 completo
- 1470/03 Ramal para lavatorio 1/2
- 1470/04 Ramal para lavatorio 1/2 completo
- 1470/01A Ramal plastico completo 3/8
- 1470/03A Ramal plastico completo 1/2
- 1470/05 Ramal plastico verde c/oring 38



REJAS DE VENTILACION(SIN APROBAR)

- 1480/07 Reja de vent. de acero inox 15 x 15 amurar
- 1480/08 Reja de vent. de acero inox 15 x 30 amurar
- 1480/09 Reja de vent. de acero inox 20 x 20 amurar

- 1480/10 Reja de vent. de acero inox 15 x 15 con agujeros
- 1480/11 Reja de vent. de acero inox 15 x 30 con agujeros
- 1480/12 Reja de vent. de acero inox 20 x 20 con agujeros



REJAS DE VENTILACION APROBADAS

- 1480/13 Reja vent. 200 cc APROBADA 15 x 15 esmaltada
- 1480/14 Reja vent. 200 cc APROBADA 15 x 30 esmaltada
- 1480/15 Reja vent. 200 cc APROBADA 20 x 20 esmaltada



REJAS PLASTICAS PARA PISO

- 1480/16 REJA PLASTICA PARA PISO C/MARCO 10 X 10
- 1480/17 REJA PLASTICA PARA PISO C/MARCO 15 X 15
- 1480/18 REJA PLASTICA PARA PISO C/MARCO 20 X 20



REJILLAS PROTECTORAS CONTRA INSECTOS

- 1490/01 Rejilla protectora 8 x 8
- 1490/02 Rejilla protectora 12 X 12
- 1490/03 Rejilla protectora 15 x 15
- 1490/04 Rejilla protectora 20 x 20



REJAS DE HIERRO FUNDIDO CON MARCO

1490/05	Reja de hierro fundido con marco 15 x 15
1490/06	Reja de hierro fundido con marco 20 x 20
1490/07	Reja de hierro fundido con marco 25 x 25
1490/08	Reja de hierro fundido con marco 30 x 30



REJAS Y TAPAS DE ACERO INOXIDABLE

1490/10	Reja acero m/piso 10 x 10
1490/11	Reja acero m/piso 12 x 12
1490/12	Reja acero m/piso 15 x 15
1490/13	Reja acero m/piso 20 x 20
1490/14	Tapa acero m/piso 10 x 10
1490/14B	Tapa acero m/piso 12 x 12
1490/15	Tapa acero m/piso 15 x 15
1490/16	Tapa acero m/piso 20 x 20



RESISTENCIAS TERMOTANQUES

1180/15	Resistencia p/termotanque 1500 Wat completa
---------	---



RESORTES DE BRONCE Y ACERO PARA BOTONES

1500/01	*RESORTE PARA BOTON FRANKLIN
1500/02	*RESORTE PARA BOTON IDEAL CORTO
1500/03	*RESORTE PARA BOTON IDEAL LARGO
1500/04	*RESORTE PARA BOTON IDEAL CONICO LEGITIMO
1500/05	*RESORTE PARA BOTON IDEAL ACERO INOXIDABLE LEGITIMO
1500/06	*RESORTE PARA BOTON FERRUM ACERO INOXIDABLE



REGULADOR PARA GARRAFA

1510/01	Regulador completo para garrafa de 10 KG x 1 mt
1510/03	Regulador garrafa 10 kg x 1,50 mt
1510/04	Regulador garrafa 10 kg x 2,00 mt
1510/05	Cabeza regulador garrafa sin manguera
1510/02	Regulador domiciliario 6mts 4bar c/flex



ROSETAS VARIAS

1510/10

Roseta 1/2 p/flexible acero

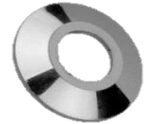

SOPORTES PLASTICOS PARA ASIEN TO INODORO



4814/90

**SOPORTE TAPA INODORO
ARIEL BUTACA 414**



4815/60

**SOPORTE TAPA INODORO
ARIEL CORTO FLORENCIA
421**



4815/61

**SOPORTE TAPA INODORO
ARIEL LARGO PILAR 406**



4815/67B

**SOPORTE TAPA INODORO
DACCORD ECONOMICO
131-132**



4815/69

**SOPORTE TAPA INODORO
DACCORD FLORENCIA
128**



4815/70

**SOPORTE TAPA INODORO
DACCORD PILAR 127**



4815/72

**SOPORTE TAPA INODORO
FERRUM ADRIATICO-
PILAR**



4815/73

**SOPORTE TAPA INODORO
CAMILLO**



4815/74

**SOPORTE TAPA INODORO
MONKOTO**



4815/75
SOPORTE TAPA INODORO
NEO-PLAX 610



4815/76
SOPORTE TAPA INODORO
NEO-PLAX 700



4815/77
SOPORTE TAPA INODORO
NEO-PLAX 740



4815/83A
SOPORTE TAPA INODORO
TIGRE



4815/84
SOPORTE TAPA INODORO
URATEL GRUESO
FLORENCIA



4815/85
TUERCA PLASTICA
P/SOPORTES DE
INODORO



4815/86
SOPORTE TAPA INODORO
URATEL FINO PILAR



4815/87
SOPORTE TAPA MADERA
INODORO UNIVERSAL



4815/88
SOPORTE TAPA MADERA
INODORO FERRUM



4815/88A
SOPORTE TAPA MADERA
BRONCE CROMO



4815/88B
SOPORTE TAPA MADERA
FERNANDEZ

SIFONES Y REPUESTOS PARA SIFONES

- 1520/01 Sifon de goma simple
- 1520/02 Sifon de goma doble
- 1520/03 Repuesto de sifon a codo
- 1520/04 Ramal para sifon
- 1520/05 Juego de codos para sifon
- 1520/06 Fuelle alargue 17 cm de goma para sifon
- 1520/07 Fuelle alargue 21 cm de goma para sifon



SOBRETAPAS DE ACERO INOX.PARA DEPOSITOS

- 1530/01 Sobretapa acero inox.para deposito FRANKLIN
- 1530/02 Sobretapa acero inox.para deposito IDEAL
- 1530/03 Sobretapa acero inox.para deposito LA PALANQUITA



SOBRETAPAS PLASTICAS PARA DEPOSITOS

- 1530/04 Sobretapa plastica para deposito FRANKLIN
- 1530/05 Sobretapa plastica para deposito IDEAL
- 1530/06 Sobretapa plastica para deposito LA PALANQUITA



SOPAPAS DE BRONCE

- 1540/03 Sopapa bronce para cocina de 2
- 1540/04 Sopapa bronce para cocina de 1 1/2
- 1540/05 Sopapa a codo bañera de bronce con adaptador de PVC
- 1540/40 Sopapa quick clack 1 1/4 DACCORD



SOPAPAS PLASTICAS



1540/06
Sopapa a codo
bañera de PVC



1540/07
Sopapa plastica
AMERICANA



1540/08
Receptaculo codo
bañera 8 x 8



1540/09 Sopapa PVC de 40 super

1540/10 Sopapa PVC de 50 super



1540/14
Sopapa importada 7 cm
c/escurreidor



1540/11 Sopapa plastica 40 con rosca 1 1/4

1540/12 Sopapa plastica 50 con rosca 1 1/2

1540/13 Sopapa tipo Johnson rosca 1 1/2



1540/15
Receptaculo recto
bañera 8 x 8

BASES PARA TANQUE

- 1140/50 Base tanque chica metalica Economica
- 1140/51 Base tanque grande metalica Economica

- 1140/54 Base para tanque 145 x 155 cm ref.

- 1140/55 Base tanque chica metalica Intermedia
- 1140/56 Base tanque grande metalica Intermedia

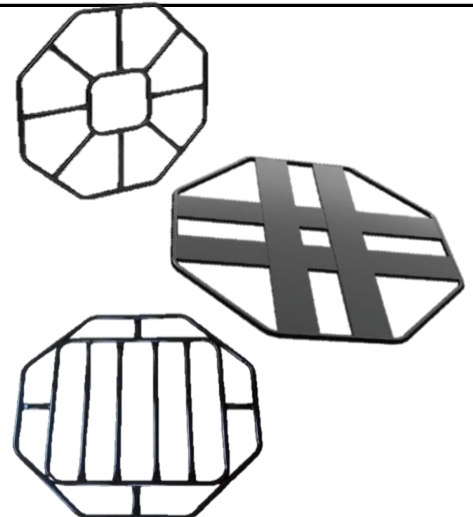

BASE TANQUE PLASTICA

- 1140/52 Base tanque Plastica chica
- 1140/53 Base tanque Plastica grande



TANQUES DE AGUA POWERLIT

1540/16	Tanque 280 lts tricapa
1540/17	Tanque 470 lts tricapa
1540/18	Tanque 500 lts Fino tricapa
1540/19	Tanque 750 lts tricapa
1540/20	Tanque 1000 lts tricapa
1540/28	Tapa para taque con aro



TANQUES DE AGUAROTOPLAS

1540/21	Tanque Forteplas 400 lts bicapa
1540/22	Tanque Forteplas 500 lts bicapa
1540/23	Tanque Forteplas 600 lts bicapa
1540/24	Tanque Rotoplas gris 400 lts tricapa
1540/25	Tanque Rotoplas gris 600 lts tricapa
1540/26	Tanque Rotoplas gris 850 lts tricapa
1540/27	Tanque Rotoplas gris 1100 lts tricapa
1540/74	Tanque Rotoplas gris 2750 lts tricapa
1540/29	Tanque Rotoplas FLAT 500 lts arena
1540/30	Tanque Rotoplas FLAT 1000 lts arena



1540/37	Tapa tanque Rotoplas con aro
---------	------------------------------



1540/70	Tanque Rotoplas beige 400 lts multicapa
1570/71	Tanque Rotoplas beige 600 lts multicapa
1540/72	Tanque Rotoplas beige 850 lts multicapa
1540/73	Tanque Rotoplas beige 1100 lts multicapa



1540/75	Biodigestor 600 lts Rotoplas
1540/76	Biodigestor 1300 lts Rotoplas



TANQUES DE AGUA WATERPLAS

1540/50	Tanque 100 lts tricapa Waterplas
1540/51	Tanque 150 lts tricapa Waterplas
1540/52	Tanque 180 lts tricapa Waterplas
1540/53	Tanque 1500 lts tricapa Waterplas
1540/54	Tanque 2000 lts tricapa Waterplas
1540/55	Tanque 2500 lts tricapa Waterplas



1540/56	Biodigestor 600 lts autolimpiable Waterplas
1540/57	Biodigestor 1100 lts autolimpiable Waterplas



1540/58	Camara de inspeccion Waterplas
---------	--------------------------------



1540/59	Camara de lodos 100 lts Waterplas
1540/60	Camara de lodos 180 lts Waterplas



TAPA CAMARA

1550/01	Tapa camara 20 x 20
1550/02	Tapa camara 25 x 25
1550/03	Tapa camara 30 x 30
1550/04	Tapa camara 40 x 40
1550/05	Tapa camara 50 x 50
1550/06	Tapa camara 60 x 60

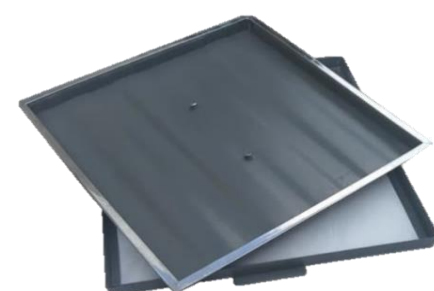

TAPAS INTERNAS PARA DEPOSITO DE PARED

1560/01	*TAPA INTERNA FIBROCEMENTO FRANKLIN
1560/02	*TAPA INTERNA FIBROCEMENTO FLUMAX ANCHA
1560/03	*TAPA INTERNA FIBROCEMENTO FLUMAX ANGOSTA



1560/04
1560/05
1560/06

*TAPA INTER.PLAST.SOLA P/DEPOSITO FRANKLIN
*TAPA INTERNA P/DEPOSITO FRANKLIN COMPLETO
*TAPA INTERNA P/DEPOSITO FRANKLIN NUEVO



1560/07
1560/08
1560/09
1560/10

*TAPA INTERNA P/DEPOSITO IDEAL ECONOMICO
*TAPA INTER.BOTON CORTO DEPOSITO IDEAL LEGITIMO
*TAPA INTER.BOTON LARGO DEPOSITO IDEAL LEGITIMO
*TAPA INT.BOTON BRONCE P/DEPOSITO IDEAL LEGITIMO



1560/14
1560/11

Tapa PALANQUITA completa blanca
*TAPA INTERNA P/DEPOSITO LA PALANQUITA



1560/12

*TAPA INTERNA P/DEPOSITO YUNQUE



1560/13

*TAPA INTERNA C/CLAVIJA ARGENTA/BROOKLIN



TAPA UNIVERSAL PARA BACHA

1560/15

Tapa para sopapa universal PVC



TEE CONEXIÓN DE LAVARROPAS

1570/01

Tee conexión de lavarropa de bronce



1570/02

Tee conexión de lavarropa de plastico



TEFLON COMUN Y DE ALTA DENSIDAD

1580/01	Teflon 1/2 x 10
1580/02	Teflon 1/2 x 20
1580/03	Teflon 3/4 x 10
1580/04	Teflon 3/4 x 20
1580/06	Teflon alta densidad 1/2 x 10
1580/07	Teflon alta densidad 3/4 x 10
1580/08	Teflon alta densidad 3/4 x 40



TERMOTANQUES SEÑORIAL

1580/50	Termotanque electrico 40 lts Señorial
1580/51	Termotanque electrico 65 lts Señorial
1580/52	Termotanque electrico 95 lts Señorial
1580/53	Termotanque multigas 85 lts Señorial
1580/54	Termotanque multigas 120 lts Señorial
1580/55	Termotanque multigas 160 lts Señorial
1580/56	Termotanque alta recuperacion multigas 30 lts Señorial
1580/57	Termotanque alta recuperacion multigas 50 lts Señorial



TOMAS DE GOMA PARA CANILLA Y MANGUERA

1590/01	Chupete de goma 1/2
1590/02	Chupete de goma 3/4



TORNILLOS COMPLETOS PARA INODORO

1610/01	Tornillo para inodoro 22 x 70
1610/02	Tornillo para inodoro 22 x 80



TUERCAS DE BRONCE PARA GRIFERIA

1620/01	Tuerca de bronce para griferia de 1/2
1620/02	Tuerca de bronce para griferia de 3/4



TUERCAS PARA BOTONES DE DEPOSITO PARED

1620/03	Tuerca externa bronce cromada corta para boton
1620/04	Tuerca externa bronce cromada larga para boton
1620/05	Tuerca externa bronce cromada extra larga para boton
1620/06	Tuerca externa plastica para boton
1620/07	Tuerca trasera de bronce para boton



TERMOCUPLAS Y ACCESORIOS

1600/01	Termocupla x 20 cm
1600/02	Termocupla x 30 cm
1600/03	Termocupla x 40 cm
1600/04	Termocupla x 50 cm
1600/05	Termocupla x 60 cm
1600/06	Termocupla x 70 cm
1600/07	Termocupla x 80 cm
1600/08	Termocupla x 90 cm
1600/09	Termocupla x 100 cm
1600/10	Termocupla x 110 cm
1600/11	Termocupla x 120 cm
1600/12	Termocupla x 130 cm
1600/13	Termocupla x 140 cm
1600/14	Termocupla x 150 cm



1600/15
TUERCA PLANA
DE AJUSTE



1600/16
TUERCA 8 X 1



1600/17
TUERCA EITAR



1600/18
TUERCA ORBIS



1600/19
TUERCA LONGVIE



1600/20
TUERCA RHEEM



1600/21
TUERCA
OTTONELLO



1600/22
TUERCA ESKABE



1600/23
SOPORTE 8 X 1



1600/24
SOPORTE EITAR



1600/25
SOPORTE ORBIS



1600/26
SOPORTE
LONGVIE



1600/27
SOPORTE
RHEEM



1600/28
SOPORTE
ESKABE 2000











1600/29
SOPORTE
ESKABE 5000

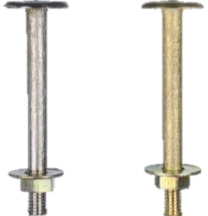

1600/30
TUERCA PARTIDA
PARA TERMOCUPLA
(8 x 1, 9 x 1, 3/8)

TORNILLOS VARIOS

1610/03	Tornillo 3/16 x 2 p/sopapa niquelado	
1610/04	Tornillo 3/16 x 3 p/sopapa niquelado	
1610/05	Tornillo 1/4 x 2 p/sopapa	
1610/06	Tornillo 3/16 x 3/8 cabeza redonda PEIRANO	
1610/07	Tornillo 3/16 x 3/8 cabeza tanque PEIRANO	
1610/08	Tornillo 5/32 x 1/2 cabeza redonda FV	
1610/09	Tornillo 5/32 x 1/2 cabeza tanque FV	
1610/10	Tornillo 5/32 con 2 tuercas p/tapa FRANKLIN	
1610/11	Bulon para tapa camara de bronce pulido	
1610/12	Bulon para tapa camara de bronce cromado	
1610/12A	Bulon para tapa camara de hierro	
1610/13	Tornillo 5/32 x 1/4 de bronce para reja de piso	
1610/14	Tornillo 5/32 x 1/4 de cromo para reja de piso	
1610/15	Tornillo 5/32 x 45 con tuerca para palanca de mochila	
1610/16	Tornillo para llave paso gas	
1610/17	Tornillo 4 mm para cabezal	

UNIDADES MAGNETICAS

- 1630/01 Unidad magnetica 11
 1630/02 Unidad magnetica 14



UNIONES MANGA PARA CANILLA

- 1640/01 Union manga 1/2 bronce pulido
 1640/02 Union manga 1/2 bronce cromado
 1640/03 Union manga 3/4 bronce pulido
 1640/04 Union manga 3/4 bronce cromado



- 1640/05 Union manga 1/2 plastica
 1640/05A Union manga 3/4 plastica



UNIONES REDUCTORAS DE BRONCE

- 1640/06 Union reductora 1/2 x 3/8
 1640/06A Union reductora 1/2 x 3/8 conica
 1640/07 Union reductora 3/4 x 1/2
 1640/08 Union reductora 3/4 x 3/8
 1640/09 Union reductora 1/2 x 1/2



VALVULAS PARA CANILLA



1650/01
VALVULA 3/8
CON TUERCA Y
GOMA



1650/02
VALVULA 1/2
CON TUERCA Y
SILICONA



1650/03
VALVULA 1/2
CON TUERCA Y
GOMA



1650/04
VALVULA 3/4 CON
TUERCA Y GOMA



1650/05
VALVULA 1
CON TUERCA



1650/06
VALVULA
TIPO
PERITA



1650/07
VALVULA 1/2
CON
ALARGUE



1650/08
VALVULA 1/2
CON TUERCA Y



1650/09
VALVULA
PEIRANO



1650/10
VALV. PEIRANO
CON TUERCA Y
GOMA



1650/11
VALVULA PEIRANO CON
TUERCA Y SILICONA



1650/12
VALVULA PEIRANO



1650/13
VALVULA PEIRANO
MODELO NUEVO

VALVULAS ALIVIO PARA TERMOTANQUE

1650/14 Valvula de seguridad para termotanque de bronce



1650/15 Valvula de seguridad para termotanque de plastica



VALVULAS DE RENTENCION DE BRONCE NACIONALES

1660/01 Valvula de retencion HH 3/4 de bronce

1660/02 Valvula de retencion HH 1 de bronce

1660/03 Valvula de retencion HH 1 1/4 de bronce

1660/04 Valvula de retencion HH 1 1/2 de bronce

1660/05 Valvula de retencion HH 2 de bronce



VALVULAS DE RENTENCION PLASTICAS

1660/06 Valvula retencion plastica con canasto 3/4

1660/07 Valvula retencion plastica con canasto 1

1660/08 Valvula retencion plastica con canasto 1 1/4

1660/09 Valvula retencion plastica con canasto 1 1/2

1660/10 Valvula retencion plastica con canasto 2



VALVULAS DE RENTENCION DE BRONCE IMPORTADAS

1660/26 Valvula retencion bronce 1/2 importada

1660/21 Valvula retencion bronce 3/4 importada

1660/22 Valvula retencion bronce 1 importada

1660/23 Valvula retencion bronce 1 1/4 importada

1660/24 Valvula retencion bronce 1 1/2 importada



VENTOSAS DESTAPA CAÑERIAS

1680/01 Ventosa con cabo

1680/02 Ventosa chica

1680/03 Ventosa gigante



VANITORYS Y BACHAS

- 1660/11 Vanitory blanco 50 cm 2 puertas c/bacha
- 1660/12 Vanitory blanco 50 cm 2 puertas sin bacha
- 1660/11B Vanitory blanco 60 cm 2 puertas c/bacha
- 1660/12B Vanitory blanco 60 cm 2 puerta sin bacha



- 1660/13 Bacha vanitory 1 o 3 agujeros 50 cm curva
- 1660/14 Bacha vanitory 1 o 3 agujeros 60 cm curva



- 1660/15 Pileta lavadero 0,52 cm sin mesada



- 1660/16 Pileta lavadero 0,75 cm mesada derecha o izquierda



- 1660/18 Peinador 50 cm c/ una luz



- 1660/19 Bacha vanitory 1 o 3 aguj. 50 cm maral recta



- 1660/20 Bacha vanitory 1 o 3 aguj. 60 cm maral recta



VOLANTES PLASTICOS PARA GRIFERIA



1670/01
VOLANTE PLASTICO
CRISTAL 70



1670/02
VOLANTE PLASTICO
CRISTAL 71



1670/03
VOLANTE PLASTICO
CRUZ 42 CROMO-
CROMO



1670/04
VOLANTE PLASTICO
FV 5 LADOS (FV 61)



1670/05
VOLANTE PLASTICO FV 4



1670/06
VOLANTE PLASTICO
SENIOR NEGRO



1670/07
VOLANTE PLASTICO
TORNADO CRISTAL



1670/08
VOLANTE AZABACHE



1670/09
VOLANTE ALEGRO



1670/10
VOLANTE AZABACHE
CRISTAL

CAMPANAS PLASTICAS



1200/01
CAMPANA PLASTICA



1200/02
CAMPANA PLASTICA



1200/03
CAMPANA PLASTICA



1200/04
CAMPANA PLASTICA



1200/04A
CAMPANA PLASTICA

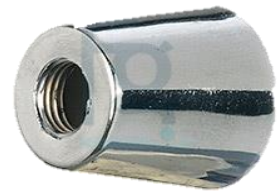

1200/05
CAMPANA PLASTICA



1200/06
CAMPANA PLASTICA PARA



1200/07
CAMPANA PLASTICA LLAVE

1200/08
CAMPANA PLASTICA



1200/11
CAMPANA PLASTICA TIPO



1200/09
CAMPANA PLASTICA



1200/10
CAMPANA PLASTICA

BOMBAS ELEVADORAS (FLUVIAL)



1140/70
BOMBA PERIFERICA
1/2 HP NERO



1140/71 Y 1140/72
BOMBA PRESURIZADORA
FLU1 Y FLU2



1140/73
BOMBA CENTRIFUGA 3/4 HP
FE750



1140/74
BOMBA CENTRIFUGA 1 HP
FE1000



1140/75
BOMBA AUTOASPIRANTE
FJET50 1/2 HP



1140/76
BOMBA AUTOASPIRANTE
FJET50 1 HP



1140/77
BOMBA CENTRIFUGA
1 1/2 HP FCG150



1140/78
BOMBA CENTRIFUGA
2 HP FCG200



1140/79
BOMBA CENTRIFUGA
3 HP FCG300



1140/80
MINIKIT PRESION 2 BOCAS



1140/81
BOMBA CENTRIFUGA
3/4 HP NACIONAL FC75



1140/82
BOMBA CENTRIFUGA
1 HP NACIONAL FC100



1140/83
BOMBA PRESURIZADORA
COMPACT MINI



1140/84
Bomba p/hidromasaje
MINIASIA

BOMBAS PLUVIUS



1140/100
Bomba periferica 1/2 hp



1140/101
Bomba presurizadora 100 wat

ASIENTO INODORO REFORZADO



1120/01



1120/02

ASIENTO INODORO PLASTICO

ASIENTO INODORO MADERA



1120/03

ASIENTO MADERA HERRAJE



1120/04

ASIENTO MADERA HERRAJE



1120/05

ASIENTOS Y REPUESTOS PARA INODORO DACCORD



1120/06
ASIENTO PLASTICO DACCORD
LIVIANO BLANCO



1120/07
ASIENTO PLASTICO DACCORD



1120/08
ASIENTO PLASTICO DACCORD
RESINA UF FLORENCIA



1120/09
ASIENTO PLASTICO DACCORD
RESINA UF PILAR



1120/10
ASIENTO PLASTICO DACCORD
RESINA UF TAURO

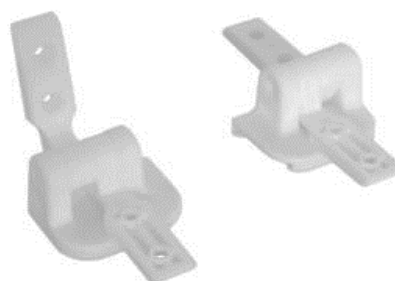

1120/11
REPUESTO ASIENTO DACCORD
INTERNO



1120/12
ASIENTO RECTANGULAR PLASTICO
DACCORD BLANCO



1120/13
ASIENTO OVAL PLASTICO DACCORD

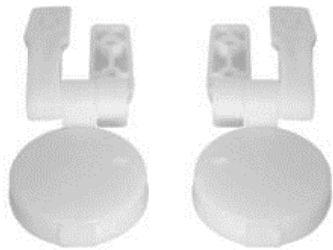

1120/14
REPUESTO ASIENTO DACCORD
REDONDO EXTERNO



1120/15
CABEZAL COMPLETO UNIVERSAL
DACCORD

BRAZOS Y LLUVIAS PLASTICAS



1170/01
BRAZO LLUVIA PLASTICO
CROMO ROSCA FINA

1170/01B
BRAZO LLUVIA PLASTICO
CROMO ROSCA GRUESA



1170/02
LLUVIA ARTICULADA
PLASTICO CROMO



1170/02B
LLUVIA GRANDE PLANA
CON ANTISARRO



1170/02C
LLUVIA IMPORTADA CROMO
CHICA ANTISARRO



1170/03
LLUVIA ARTICULADA
PLASTICA SIMIL POMBA FV



1170/03A
LLUVIA ARTICULADA
PLASTICA SIMIL POMBA FV
ANTISARRO



1170/03B
LLUVIA PLASTICA PARA
BIDET TIPO PEIRANO



1170/03C
LLUVIA REDONDA 8 PULGADAS
ACERO

1170/09
LLUVIA REDONDA 6 PULGADAS
ACERO (8990)



1170/03D
LLUVIA CUADRADA 8 PULGADAS
ACERO (8994)

1170/10
LLUVIA CUADRADA 6 PULGADAS
ACERO (8993)



1170/06
LLUVIA CON BRAZO Y ROCETA
MOZART (2103)



1170/07
LLUVIA TUBO REDONDO CON
BRAZO MOZART (2112)



1170/08
LLUVIA CON BRAZO Y ROCETA
CUADRADA MOZART (2225)



1170/11
LLUVIA REDONDA ALTA GRIS
COMPLETA (9377)

BRAZO DE BRONCE PARA LLUVIA

1170/04 Brazo lluvia bronce 45° x 16 cm
 1117/04A Brazo lluvia bronce 45° x 21 cm

1170/05 Brazo lluvia bronce 90° x 30 cm
 1170/05A Brazo lluvia bronce 90° x 40 cm
 1170/05B Brazo lluvia bronce 90° x 45 cm
 1170/05C Brazo lluvia bronce 90° x 50 cm



LOZA CAPEA / PRIMA



**INODORO CORTO
CAPEA**



**INODORO LARGO CAPEA
1370/51**



**BIDET 1 O 3 AGUJEROS
1370/52**



**COLUMNA CAPEA
1370/53**



**MOCHILA COLGAR CAPEA
1370/54**



**MOCHILA APOYO
CAPEA
1370/55**



**PILETA LAVATORIO CHICA 1 O 3
AGUJEROS
1370/56**



**PILETA LAVATORIO GRANDE 1 O 3
AGUJEROS
1370/57**



**BACHA LOZA BLANCA
1370/60**



**MOCHILA COLGAR PRIMA
1370/30**



**INODORO CORTO
FERRUM ANDINA
1370/35**



**INODORO CORTO DECA
1370/10**

LOZA SANITARIA ALBERTI



**INODORO CORTO
ALBERTI
1370/61**



**MOCHILA COLGAR
ALBERTI
1370/62**



**COLUMNA ALBERTI
1370/63**



**LAVATORIO 3
AGUJEROS
1370/64**



**LAVATORIO 1 AGUJERO
1370/65**



**BIDET ALBERTI
1370/66**

JUEGOS DE GRIFERIA NACIONAL 100% BRONCE



**1350/20
MEZCLADOR PARA**



**1350/21
MEZCLADOR PARA
PARED PICO MOVIL**



**1350/22
MEZCLADOR PARA
PARED PICO FIJO
EMBUTIR**



**1350/23
MEZCLADOR PARA
PARED EXTERIOR**



**1350/24
MEZCLADOR PARA
LAVATORIO**



**1350/25
MEZCLADOR PARA
BIDET**



**1350/26
MEZCLADOR DUCHA
CON
TRANSFERENCIA**



**1350/27
MEZCLADOR
DUCHA SIN
TRANSFERENCIA**



**1350/28
MEZCLADOR
DUCHA EXTERIOR
CON DUCHADOR**



JUEGOS DE GRIFERIA VOLANTES PLASTICOS SUDAMERICANA



**1350/60
MEZCLADOR PARA
MESADA**



**1350/61
MEZCLADOR PARA
LAVATORIO**



**1350/62
MEZCLADOR PARA
BIDET**



**1350/63
MEZCLADOR
DUCHA CON
TRANSFERENCIA**

JUEGOS DE GRIFERIA Y MONOCOMANDO MOZART

LINEA MADRID



**1350/29
MONOCOMANDO DE**



**1350/29A
MONOCOMANDO MESADA
PICO ALTO FINO
(8582)**



**1350/29B
MONOCOMANDO
MESADA PICO ALTO
GRUESO (8583)**



**1350/31
MONOCOMANDO DE
PARED (9024)**



**1350/32
MONOCOMANDO DE
PESADA PICO
COLOR (8363)**



**1350/32A
MONOCOMANDO
NUEVA COLOR
CONICA (8221)**

LINEA MADRID



**1350/30
MONOCOMANDO DE
MESADA CON BASE
(9025)**



**1350/32C
GRIFERIA PARED
TIPO ITALIANA
VOLANTE CRUZ
(8579)**



**1350/33
GRIFERIA MESADA
TIPO ITALIANA
VOLANTE CRUZ
(8577)**



**1350/39
MONOCOMANDO DE
BIDET (2144)**



**1350/40
MONOCOMANDO
LAVATORIO (9035)**



**1350/41
MONOCOMANDO
DUCHA CON
TRANSFERENCIA
(2020)**

LINEA MADRID



**1350/34B
MONOCOMANDO
CASCADA
LAVATORIO
REDONDO (9580)**



**1350/37
MONOCOMANDO DE
LAVATORIO ALTO
7CM (9038)**



**1350/37A
MONOCOMANDO DE
LAVATORIO ALTO
22CM (9039)**



**1350/70
MONOCOMANDO
MESADA NEGRA
PICO GRUESO (7584)**

PRESSMATIC



**1350/43
CANILLA
PRESSMATIC
MIGITORIO (7596)**



**1350/44
CANILLA
PRESSMATIC
LAVATORIO (9036)**



**1350/45
CANILLA
PRESSMATIC
LAVATORIO GRUESO
(7592)**

LINEA PREMIUM



**1350/42
MONOCOMANDO
COCINA GOURMET
(7186)**



**1350/38
MONOCOMANDO
PRAGA PICO BAR
ACERO 304 (7198)**

LINEA VITRA



**1350/32B
MONOCOMANDO DE
LAVATORIO (9407)**



**1350/33B
MONOCOMANDO DE
BIDET CON
TRANSFERENCIA
(9409)**



**1350/34
MONOCOMANDO DE
DUCHA (9408)**

JUEGOS DE GRIFERIA MAJOS NACIONAL



**1350/50
GRIFERIA
COCINA
MESADA**



**1350/51 1350/52
GRIFERIA PARED
EMBUTIR Y
EXTERIOR**



**1350/51 1350/52
GRIFERIA PARED
EMBUTIR Y
EXTERIOR**



**1350/53
GRIFERIA
LAVATORIO**



**1350/54
GRIFERIA BIDET**



**1350/55
GRIFERIA DUCHA SIN
TRANSFERENCIA**



**1350/56
GRIFERIA DUCHA CON
TRANSFERENCIA**



1350/57
GRIFERIA DUCHA
EXTERIOR. TREVI



1350/58
GRIFERIA COCINA
MESADA LYON



1350/59
GRIFERIA COCINA
MESADA NEO VOL. ABS

JUEGOS DE GRIFERIA PLASTICA



1350/20A
MEZCLADOR PARA
MESADA



1350/23A
MEZCLADOR PARA
PARED



1350/27A
MEZCLADOR DUCHA



1350/24A
MEZCLADOR PARA
LAVATORIO



1350/25A

REPUESTOS VARIOS PARA GRIFERIA

- 1490/30 Arandelas partidas chicas
- 1490/31 Arandelas partidas grandes



- 1490/32 Conexión bidet con tuerca y goma 1/2
- 1490/33 Conexión bidet con tuerca y goma 3/8



- 1490/34 Tuerca 26 x 1,5 x 6 plastica
- 1490/35 Tuerca 28 x 1,5 x 6 plastica
- 1490/36 Tuerca 30 grande plastica



- 1490/37 Tuerca ramal 1/2 plastica
- 1490/38 Tuerca ramal 3/8 plastica
- 1490/39 Tuerca ramal 1/2 agujero 3/8 plastica



- 1490/40 Tuerca plastica para griferia 1/2
- 1490/41 Tuerca plastica para griferia 3/4



- 1490/42 Bajada lluvia hembra 1/2



- 1490/43 Bajada lluvia macho 1/2

- 1490/44 Bajada lluvia macho 3/4 x 1/2



REPUESTOS PARA MOCHILA Y DEPOSITO IDEAL



4729/92
BRAZO CON FORMA Y
MARIPOSA PLAST.
PARA FLOTANTE IDEAL



4729/98
CADENA PARA
DEPOSITO DE COLGAR



4730
CLAVIJA FLOTANTE
A CODO IDEAL



4730/01
FLOTANTE PLAST.
CODO CON BRAZO
Y CLAVIJA IDEAL



4730/04
FLOTANTE PLAST.
PARA DEPOSITO
CADENA IDEAL



4730/10
PERILLA PLASTICA
PARA TIRADOR
IDEAL



4730/15
PISTON PARA
FLOTANTE A CODO
IDEAL



4730/23
TAPA CON
PULSADOR PARA
MOCHILAS DASH Y
TRADIC. IDEAL



4730/20
TIRADOR
P/OBTURADOR
MOCHILA IDEAL



4730/25
VALVULA ENTRADA
AGUA MOCHILA
DASH IDEAL



4730/26
VALVULA ENTRADA
AGUA MOCHILA
TRADICIONAL IDEAL

REPUESTOS FLUMAX



4720/20
CAMARA
SILENCIOSA FLUMAX

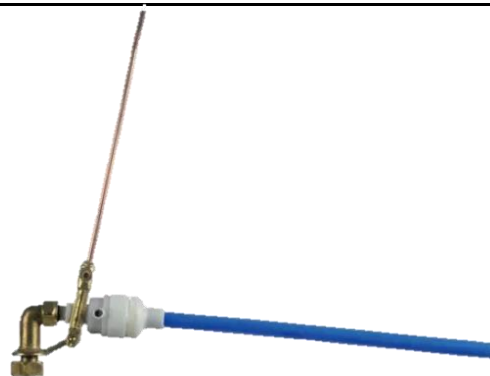

4720/21
FLOTANTE
INTERCAMBIABLE H.A
CODO FLUMAX



4720/22
FLOTANTE
INTERCAMBIABLE M.A
CODO FLUMAX

REPUESTOS PARA DEPOSITO FRANKLIN



4720/16
FLOTANTE
BRONCE
INTERCAMBIABLE
FRANKLIN



4720/30
PISTON DE
BRONCE
FRANKLIN

REPUESTOS PARA MOCHILA CAPEA



4689/80
ARANDELA T 66
CONICA P/DESCARGA
APOYO



4690
ARANDELA T 80
CONICA DE APOYO
MOCHILA



4690/01
ARANDELA DE AJUSTE
DESCARGA CODO CAPEA



4690/14
CODO C/TUERCA Y
ARANDELA P/DESCARGA
CAPEA



4690/16
DESCARGA DE APOYO
P/MOCHILA CAPEA



4690/17
DESCARGA A CODO
P/MOCHILA CAPEA



4690/18
DESCARGA DE APOYO
CAPEA-DELTA CON
FLAPPER



4690/20
FLAPPER RIGIDO
DEALER macho
(930212)



4690/21
FLAPPER RIGIDO DEALER
hembra (930202)



4690/22
CADENA PARA
FLAPPER



4691/30
PERILLA PLASTICA
P/TIRADOR CAPEA-DELTA



4691/32
PERILLA C/TIRADOR
P/MOCHILA CAPEA-VENECIA



4691/34
PISTON P/VALVULA
CAPEA-DELTA



4691/36
PULSADOR P/BOTON
LATERAL-SUPERIOR



4691/40
TOPE DE GOMA P/PISTON
VALVULA CAPEA-DELTA



4691/42
TUERCA C/ARANDELA
P/CODO CAPEA



4691/43
TUERCA AJUSTE
P/DESCARGA APOYO
CAPEA



4691/44
VALVULA ENTRADA AGUA
CAPEA-DELTA

REPUESTOS PARA MOCHILA FERRUM



4699
ASIENTO P/OBTURADOR
MOCHILA



4699/01
ADAPTADOR BRONCE 5/16"
X 1/2" VALVULA FERRUM



4699/20
ARANDELA T 80 PLANA
P/APOYO MOCHILA



4699/21
ARANDELA T 80 PLANA
P/APOYO MOCHILA SIMIL
ORIGINAL



4699/22
ARANDELA T 66 AJUSTE
CODO FERRUM



4699/24
ARANDELA AJUSTE
ENTRADA AGUA 3/8"



4699/26
ARANDELA AJUSTE
ENTRADA AGUA 1/2"



4699/27
ARANDELA AJUSTE
TORNILLO FENIX



4699/28
BUJE ESTRIADO P/PALANCA
DE FIJACION



4699/30
BUJE ROSCADO VERONA



4699/32
BUJE PARA MANIJA
CUADRADA



4699/34
BUJE PARA
MANIJA ESTRIADA



4699/36
CABEZA P/ENTRADA
AGUA PASO GRUESO



4699/38
CABEZA P/ENTRADA
AGUA PASO FINO



4700/20
CODO CORTO DE
MOCHILA



4700/21
CODO LARGO DE
MOCHILA



4700/22
CHAVETA PLASTICA
ENTRADA AGUA



4700/24
DESCARGA APOYO C/VASO
MODELO ACTUAL



4700/23
DESCARGA APOYO
C/FLAPPER MODELO
ANTIGUO



4700/25
DESCARGA A CODO C/FLAPPER
MODELO ANTIGUO



4700/26
DESCARGA A CODO C/VASO
MODELO ACTUAL



4700/28
DIAFRAGMA
PVC.P/ENTRADA AGUA
1/2" Y 3/8"



4700/29
DIAFRAGMA GOMA
P.AGUA 1/2" Y 3/8"



4700/30
FLAPPER RIGIDO
P/DESCARGA C/ALETA



4700/31
FLAPPER P/DESCARGA
MODELO ANTIGUO C/ALETA



4700/32
FLAPPER P/DESCARGA
MODELO P/VASITO S/ALETA



4700/33
FLAPPER CON VASO
PLASTICO COMPLETO



4700/34
GUIA O ESTRELLA
P/OBTURADOR DE MOCHILA



4700/35
MANIJA PLASTICA
ESTRIADA CROMO



4700/36
MANIJA PLASTICA
CUADRADA CROMO



4700/37
MANIJA METALICA
ESTRIADA CROMO



4700/38
MANIJA CUADRADA
METALICA CROMO



4700/39
PERILLA DE
PLASTICO CROMO
ROSCA 3/16



4700/39A
PERILLA DE PLASTICO
CROMO ROSCA 1/4



4700/40
PERILLA LOZA
BLANCA



4700/41
PERILLA LOZA
COLOR

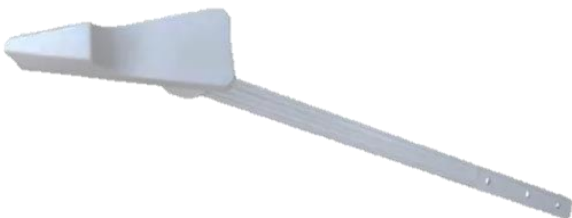

4700/42
PALANCA ANDINA
PLASTICA BLANCA



4700/42A
PALANCA ANDINA
PLASTICA CROMO



4700/42B
PALANCA ANDINA
PLASTICA BLANCA NUEVA



4700/43A
PALANCA ANDINA
METALICA



4700/45
PALANCA PLASTICA
P/MANIJA ESTRIADA



4700/46
PALANCA PLASTICA COMPLETA
P/MANIJA ESTRIADA



4700/47
PALANCA METALICA
P/MANIJA CUADRADA



4700/48
PISTON PLAST.CORTO
P/ENTRADA DE AGUA
MOCHILA



4700/49
PRECINTO C/GANCHOS
LEVANTA FLAPPER



4700/50
PRECINTO LEVANTA
FLAPPER SERRUCHO
FINO



4700/51
PRECINTO LEVANTA
FLAPPER SERRUCHO ANCHO



4700/52
PUENTE DE FIJACION
CORTO



4700/53
PUENTE DE FIJACION
LARGO



4700/54
PUENTE DE FIJACION
VERONA



4700/55
TUERCA AJUSTE
PLAST.ENTRADA AGUA DE 3/8"



4700/56
TUERCA AJUSTE
PLAST.ENTRADA AGUA DE 1/2"



4700/58
TUERCA DE AJUSTE
P/CODO CORTO



4700/59
TUERCA DE AJUSTE
P/CODO LARGO



4700/60
TUERCA DE AJUSTE
P/DESCARGAS FERRUM

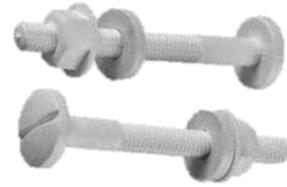

4700/62
TORNILLO PLASTICO
P/MOCHILA



4700/63
TORNILLO DE BRONCE
P/MOCHILA



4700/64
TORNILLO FENIX
P/MOCHILA



4700/64A
VALVULA ENTRADA
AGUA PLASTICA 3/8"
ALT. REGULABLE



4700/71B
VALVULA ENTRADA
AGUA PLASTICA 1/2"
ALT. REGULABLE

- 4700/65 *VALVULA ENTRADA AGUA PLASTICA 3/8" X 37 CM
- 4700/66 *VALVULA ENTRADA AGUA PLASTICA 3/8" X 33 CM
- 4700/67 *VALVULA ENTRADA AGUA PLASTICA 3/8" X 29 CM
- 4700/68 *VALVULA ENTRADA AGUA PLASTICA 3/8" X 22 CM
- 4700/68A *VALVULA ENTRADA AGUA PLASTICA 1/2" X 37 CM
- 4700/69 *VALVULA ENTRADA AGUA PLASTICA 1/2" X 33 CM
- 4700/70 *VALVULA ENTRADA AGUA PLASTICA 1/2" X 29 CM
- 4700/71 *VALVULA ENTRADA AGUA PLASTICA 1/2" X 22 CM



- 4700/72 *VALVULA ENTRADA AGUA BRONCE 3/8" X 37 CM
- 4700/73 *VALVULA ENTRADA AGUA BRONCE 3/8" X 33 CM
- 4700/74 *VALVULA ENTRADA AGUA BRONCE 3/8" X 29 CM
- 4700/75 *VALVULA ENTRADA AGUA BRONCE 3/8" X 22 CM
- 4700/76 *VALVULA ENTRADA AGUA BRONCE 1/2" X 37 CM
- 4700/77 *VALVULA ENTRADA AGUA BRONCE 1/2" X 33 CM
- 4700/78 *VALVULA ENTRADA AGUA BRONCE 1/2" X 29 CM
- 4700/79 *VALVULA ENTRADA AGUA BRONCE 1/2" X 22 CM



4700/84
VALVULA ENTRADA AGUA
SIMIL ORIGINAL (411023)



4700/85
VALVULA ENTRADA
ECONOMICA COMPLETA
TIPO AMERICANA



4700/98
PRECINTO LEVANTA
FLAPPER DEALER

REPUESTOS PARA MOCHILA MOTTA



4709
ARANDELA O JUNTA DE
APOYO MOCHILA MOTTA



4709/06
CONJUNTO COMPLETO
A CODO MOTTA



4709/05
CONJUNTO COMPLETO
APOYO MOTTA



4709/08
CONJUNTO APOYO
C/BOTON NEUMATICO
MOTTA



4710
DESCARGA APOYO
MOTTA (430312)



4710/01
DESCARGA A CODO
MOTTA



4710/05
DIAFRAGMA
OBTURADOR
P/DESCARGA
MOTTA

REPUESTOS PARA MOCHILA ROCA



4710/18
CODO PARA DESCARGA
ROCA 2
(440229)



4710/19
CODO PARA DESCARGA
ROCA 1 1/2
(440219)



4710/20
DESCARGA
APOYO CON
BOTON ROCA
NACIONAL



4710/21
DESCARGA
APOYO
ROCA
NACIONAL
(430222)



4710/21B
DESCARGA APOYO
MCHILA ROCA ORIGINAL



4710/21A
DIAFRAGMA-OBTURADOR
PARA DESCARGA ROCA
ORIGINAL



4710/21C
DESCARGA AQUA
DUO
(430552)



4710/21D
DESCARGA ROCA
NACIONAL ECO CON BOTON



4710/22
***VALVULA ENTRADA 3/8" ROCA**
ORIGINAL (415010)



4710/23
***VALVULA ENTRADA**
1/2" ROCA ORIGINAL
(415022)



4710/24
DESCARGA AQUA DUO PLUS
(430562)



4710/25
DESCARGA AQUA STOP
(430752)



4710/26
VALVULA ADM. INTEGRAL
3/8 REGULABLE
(412010)



4710/27
VALVULA ADM.
INTEGRAL 3/8
REGULABLE
(412020)



4710/28
DESCARGA LATERAL
ECOFLUSH
(430212)



4710/29
FIJACION INODORO
ROCA DAMA (445330)



4710/30
GOMA PARA EXTENSIBLE
DEALER 2 (440420)



4710/30A
GOMA PARA EXTENSIBLE
DEALER 1 1/2 (440410)

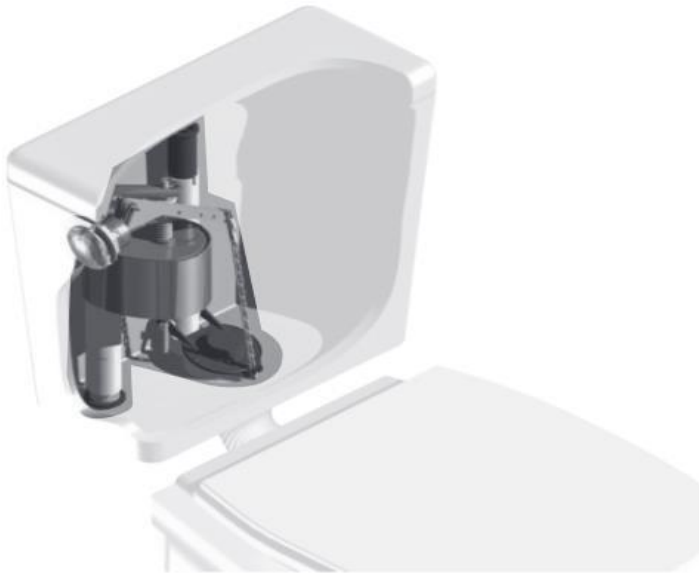

**4710/31
AQUA KIT A
CODO
LATERAL
(491155)**

**4710/32
AQUA KIT A
CODO
SUPERIOR
(491255)**

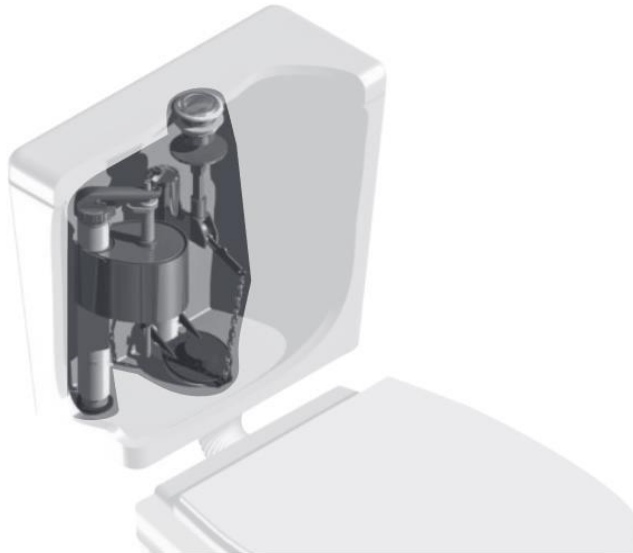

**4710/33
AQUA KIT
APOYO
LATERAL**

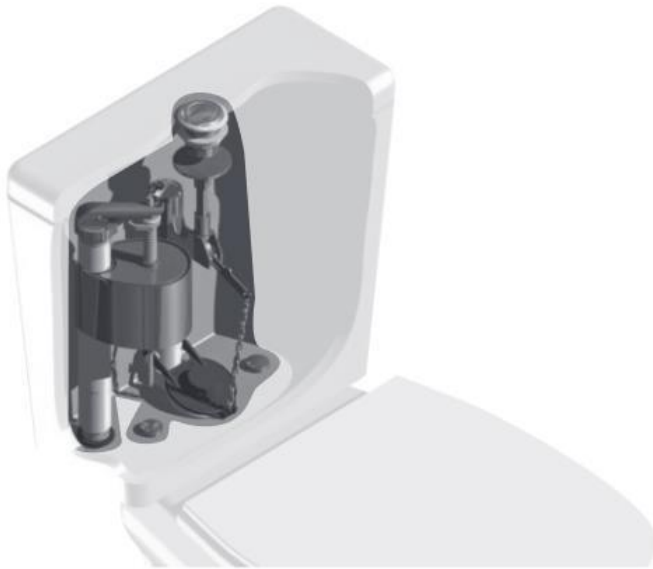

**4710/34
AQUA KIT
APOYO
SUPERIOR
(491254)**

**4710/35
AQUA KIT
APOYO
FRONTAL
(491354)**

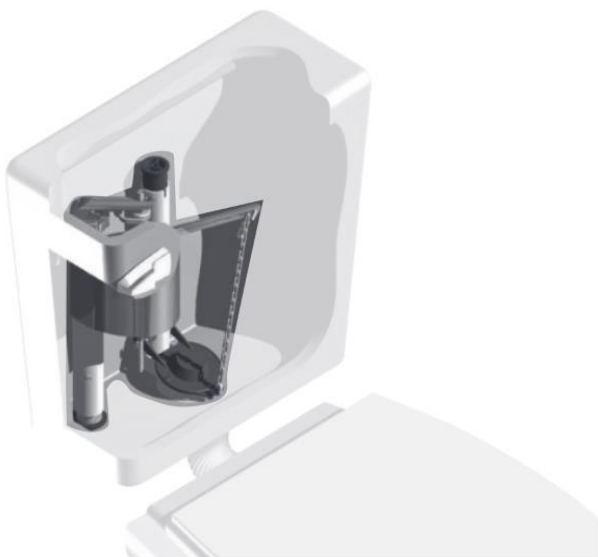
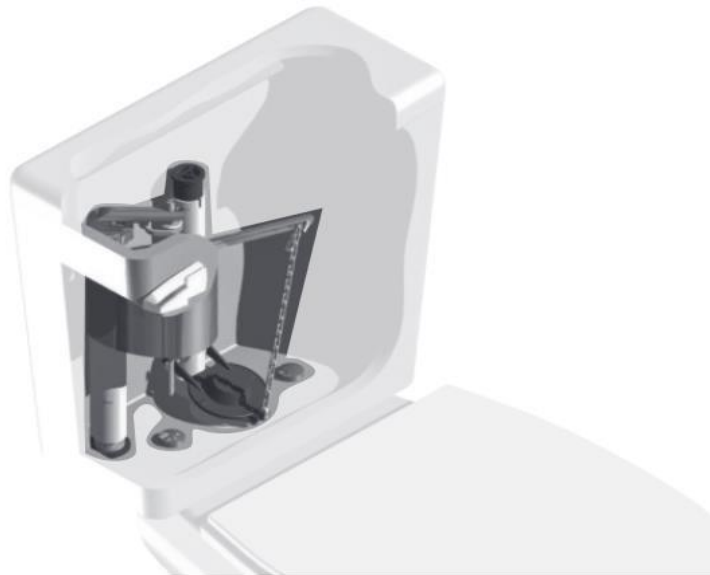

**4710/36
AQUA KIT A
CODO
FRONTAL
(491355)**